

中国高端电脑缝纫机

CHINESE HIGH-END COMPUTERIZED SEWING MACHINE

HIKARI® 富山

使用说明书

INSTRUCTION MANUAL

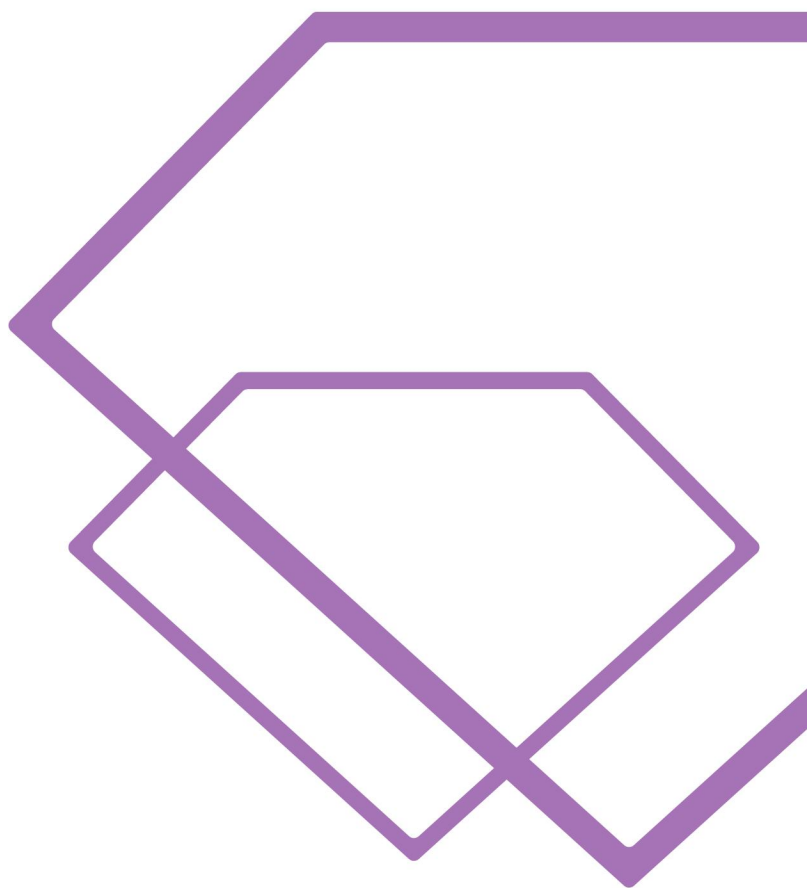

HK2900 系列
Series

电脑直驱套结机

COMPUTER BAR-TACKING MACHINE

V1.00

20X

套结钉扣机（触摸屏E）

Bar-tacking and Button Sewing Machine (Touching Panel E)

前 言

欢迎您使用本公司的特种缝纫机控制系统。

请您仔细阅读本操作手册，以确保正确的操作、使用特种缝纫机，请按照本手册内注明的方式进行操作，否则，如违规操作所造成损失本公司不承担责任。此外，请将本用户手册妥善保存在安全地点，以便随时查阅。若发生故障须由本公司指定的技术人员或专业人员进行维修。

Foreword





Thank you for using our Computerized Control System for Special Sewing Machine.

It is appreciated that you do read this manual carefully in order to operate the machine correctly and effectively. If the user operates the machine contrary to regulations herein, thus cause loss to user or third party, we will not take responsibility. Besides, you should keep this manual for future use. For any fault or problem of machine, please ask the professionals or the technicians authorized by us for repair service



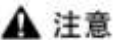



安全注意事项

1. 安全操作的标志及含义







本使用说明书及产品所使用的安全标志是为了让您正确安全的使用产品，防止您及其他人受到伤害。标志的图案和含义如下：

 危险	如果忽视此标记而进行错误的操作，会导致人员的重伤或死亡。
 注意	如果忽视此标记而进行错误的操作，会导致人员的受伤和设备的损坏。
	该符号表示“应注意事项”。三角中的图案表示必须要注意的内容。（例如左边的图案表示：“当心受伤”）
	该符号表示“禁止”
	该符号表示“必须”。圆圈中的图案表示必须要做的内容。（例如左边的图案表示“必须接地”）

2. 安全注意事项

 危险	
	打开控制箱时，先关闭电源开关并将电源插头从插座上拔下后，等待至少 5 分钟后，再打开控制箱盖。触摸带有高电压的区域会造成人员受伤。
 注意	
使用环境	
	应避免在强电气干扰源（如高频焊机）的附近使用本缝纫机。 强电气干扰源可能会影响缝纫机的正常操作。
	电源电压的波动应该在额定电压的±10%以内的环境下使用。 电压大幅度的波动会影响缝纫机的正常操作，需配备稳压器。
	环境温度应在 0℃~45℃的范围内使用。 低温或高温会影响缝纫机的正常操作。
	相对湿度应在 35%~85%的范围内，并且设备内不会形成结露的环境下使用。





	干燥、潮湿或结露的环境会影响缝纫机的正确操作。
	压缩空气的供气量应大于缝纫机所要求的总耗气量。压缩空气的供气量不足会导致缝纫机的动作不正常。
	万一发生雷电暴风雨时，关闭电源开关，并将电源插头从插座上拔下。雷电可能会影响缝纫机的正确操作。
安装	
	请让受过培训的技术人员来安装缝纫机。
	安装完成前，请不要连接电源。 如果误按启动开关，缝纫机动作会导致受伤。
	缝纫机头倒下或竖起时，请用双手操作。不要用力压缝纫机。 如缝纫机失去平衡，缝纫机滑落到地上会造成受伤或机器损坏。
	必须接地。 接驳地线不牢固，是造成触电或误动作的原因。
	所有电缆应固定在离活动部件至少 25mm 以外处。另外，不要过度弯曲或用卡钉固定得过紧。会引起火灾或触电的危险。
	请在机头上安装安全罩壳。
缝纫	
	本缝纫机仅限于接受过安全操作培训的人员使用。
	本缝纫机不能用于除缝纫外的任何用途。
	使用缝纫机时必须戴上保护眼镜。 如果不戴保护眼镜，断针时机针折断部分可能会弹入眼睛造成伤害。
	发生下列情况时，请立即切断电源。否则误按下启动开关时，会导致受伤。 1.机针穿线时 2.更换机针时 3.缝纫机不使用或人离开缝纫机时
	缝纫过程中，不要触摸任何运动部件或将物件靠在运动部件上，因为这会导致人员受伤或缝纫机损坏。
	如果缝纫机操作中发生误动作，或听到异常的噪声或闻到异常的气味，应立即切断电源。然后请与购买商店或受过培训的技术人员联系。

	如果缝纫机出现故障，请与购买商店或受过培训的技术人员联系。
维护和检查	
	只有经过训练的技术人员才能进行缝纫机的维修、保养和检查。
	与电气有关的维修、保养和检查请及时与电控厂家的专业人员进行联系。
	发生下列情况时，请关闭电源并拔下电源插头。否则误按启动开关时，会导致受伤。 1. 检查、调整和维修 2. 更换弯针、切刀等易损零部件
	在检查、调整和修理任何使用气动设备之前，请先断开气源，并等压力表指针下降到“0”为止。
	在必须接上电源开关和气源开关进行调整时，务必十分小心遵守所有的安全注意事项。
	未经授权而对缝纫机进行改装而引起的缝纫机损坏不在保修范围内。





Safety Matters for Attention











1. Signs & Definitions of Safety Marks

This User's Manual and the Safety Marks printed on the products are to enable you to use this product correctly so as to be away from personal injury. The signs and definitions of Marks are shown in below:









 Danger Danger	The incorrect operation due to negligence will cause the serious personal injury or even death.
 Caution Caution	The incorrect operation due to negligence will cause the personal injury and the damage of mechanism.
	This kind of marks is "Matters for Attention", and the figure inside the triangle is the content for attention. (Exp. The left figure is "Watch Your Hand!")
	This kind of mark is "Forbidden".
	This kind of mark means "Must". The figure in the circle is the contents that have to be done. (Exp. The left figure is "Ground!")





2. Safety Matters for Attention

 Danger Danger	
	For opening the control box, please turn off the power and take away the plug from socket firstly, and then wait for at least 5 minutes before opening the control box. Touching the part with high voltage will cause the person injury.
 Caution Caution	
Usage Environment	
	<p>Try not to use this sewing machine near the sources of strong disturbance like high-frequency welding machine.</p> <p>The source of strong disturbance will affect the normal operation of the</p>

	sewing machine.
	The voltage fluctuation shall be within 10% of the rated voltage. The large fluctuation of voltage will affect the normal operations of sewing machine, Therefore a voltage regulator is needed in that situation.
	Working temperature:0°C~45°C. The operation of the sewing machine will be affected by environment with temperature beyond the above range.
	Relative Humidity: 35% ~ 85%(No dew inside the machine), or the operation of sewing machine will be affected.
	The supply of compressed gas shall be over the consumption required by the sewing machine. The insufficient supply of compressed gas will lead to the abnormal action of sewing machine.
	In case of thunder, lightning or storm, please turn off the power and pull plug out the socket. Because these will have influence on the operation of sewing machine.
Installation	
	Please ask the trained technicians to install the sewing machine.
	Don' t connect machine to power supply until the installation is finished. Otherwise the action of sewing machine may cause personal injury once the start switch is pressed at that situation by mistake.
	When you tilt or erect the head of sewing machine, please use both of your hand in that operation. And never press the sewing machine with strength. If the sewing machine loses its balance, it will fall into floor thus causes the personal injury or mechanical damage.
	Grounding is a must. If the grounding cable is not fixed, it may cause the electric-shock and mis-operation of machine
	The entire cables shall be fixed with a distance at 25mm away from the moving component at least. By the way, don't excessively bend or tightly

	fixed the cable with nails or clamps, or it may cause the fire or electric shock.
	Please add security cover on the machine head.

Sewing	
	This sewing machine can only be used by the trained staff.
	This sewing machine has no other usages but the sewing.
	When operating the sewing machine, please remember to put on the glasses. Otherwise, the broken needle will cause the personal injury in case the needle is broken.
	At following circumstances, please cut off the power at once so as to avoid the personal injury caused by the mis-operation of start switch: 1.Threading on needles; 2. Replacement of needles; 3. The sewing machine is left unused or beyond supervision
	At working, don't touch or lean anything on the moving components, because both of the above behaviors will cause the personal injury or the damage of the sewing machine.
	During working, if the mis-operation happens or the abnormal noise or smell is found at the sewing machine, user shall cut off the power at once, and then contact the trained technicians or the supplier of that machine for solution.
	For any trouble, please contact the trained technicians or the supplier of that machine.
Maintenance & Inspection	
	Only can the trained technicians perform the repair, maintenance and inspection of this sewing machine.
	For the repair, maintenance and inspection of the electrical component, please contact the professionals at the manufacturer of control system in

	time.
	<p>At following circumstances, please cut off the power and pull off the plug at once so as to avoid the personal injury caused by the mis-operation of start switch.:</p> <ol style="list-style-type: none"> 1.Repair, adjustment and inspection ; 2.Replacement of the component like curve needle, knife and so on
	<p>Before the inspection, adjustment or repair of any gas-driven devices, user shall cut off the gas supply till the pressure indicator falls to 0.</p>
	<p>When adjusting the devices needing the power supply and gas supply, users can' t be too careful to follow the entire Safety Matters for Attention.</p>
	<p>If the sewing machine damages due to the unauthorized modification, our company will not be responsible for it.</p>

目录

1 概要说明.....	1
1.1 概述.....	1
1.2 技术参数表.....	1
1.3 安全使用注意事项.....	2
1.4 使用上的预防措施.....	4
1.5 标准化.....	6
1.6 操作方式.....	6
2 操作说明.....	7
2.1 通用按键.....	7
2.2 基本操作.....	8
2.3 普通花样操作.....	9
2.4 花样登记.....	13
2.5 花样命名.....	14
2.6 绕线.....	14
2.7 花样选择.....	16
2.8 缝纫数据设定.....	18
2.9 P 花样登记.....	20
2.10 试缝操作.....	20
2.11 计数器操作.....	22
2.12 急停.....	23
2.13 单针线张力设置.....	25
3 快捷 (P) 花样操作.....	27
3.1 P 花样数据输入.....	27
3.2 P 花样编辑.....	29
3.3 P 花样复制.....	30
3.4 P 花样选择.....	31
3.5 P 花样缝制.....	32
4 组合 (C) 花样操作.....	35
4.1 C 花样数据输入.....	35
4.2 C 花样编辑.....	36

4.3 C 花样选择.....	38
4.4 C 花样缝制.....	39
5 花样图案编辑.....	41
5.1 进入花样编辑模式.....	41
5.2 花样编辑.....	45
5.3 退出花样编辑模式.....	50
6 信息功能.....	52
6.1 查看维修保养信息.....	52
6.2 维修保养时间设置.....	53
6.3 警告的解除方法.....	55
6.4 生产管理信息.....	55
6.4.1 从信息界面显示.....	56
6.4.2 从缝制界面显示.....	57
6.4.3 生产管理信息设定.....	58
6.5 显示穿线图.....	61
6.6 报警记录.....	62
6.7 运转记录.....	64
6.8 分期密码设置.....	64
7 通讯功能.....	72
7.1 关于可以处理的数据.....	72
7.2 功能操作.....	73
7.3 花样传输.....	73
7.4 参数传输.....	77
7.5 软件升级.....	79
8 模式和参数设置.....	81
8.1 功能说明.....	82
8.2 一级参数设置.....	83
8.3 二级参数设置.....	89
8.4 计数器设置.....	92
8.4.1 功能介绍.....	93
8.5 变换缝制类型.....	94

8.6 进入花样编辑.....	95
8.7 花样锁定设置.....	95
8.8 格式化操作.....	96
8.9 软件版本查询.....	98
8.10 检测模式.....	99
8.11 锁键盘操作.....	106
8.12 参数备份设置.....	108
8.13 钉扣机型设置.....	109
8.14 花样编辑参数设置.....	112
9 电控系统原理.....	113
9.1 控制系统组成.....	113
9.1.1 电控箱安装尺寸.....	113
9.1.2 操作头安装尺寸.....	113
9.1.3 系统框图.....	114
9.1.4 控制箱的外部线缆连接.....	117
9.2 1900A 套结机花样一览表.....	119
9.3 钉扣机花样一览表.....	122
9.4 1906A 套结花样一览表.....	123
9.5 报警信息一览表.....	127
9.6 信息提示一览表.....	130

Contents

1 General Information	137
1.1 General	137
1.2 Technical Parameters	137
1.3 Matters for Safe Using	138
1.4 The Preventions on Usage	140
1.5 Standardization	141
1.6 Operation Method	141
2 Operating Instruction	143
2.1 Common Buttons	143
2.2 Basic Operation	144
2.3 Operation of Normal Pattern	145
2.4 Pattern Registration	149
2.5 Pattern Naming	150
2.6 Winding	150
2.7 Pattern Selection	152
2.8 Sewing Data Setting	154
2.9 P Pattern Registration	156
2.10 Trial Sewing	157
2.11 Counter Operation	159
2.12 Emergency Stop	160
2.13 Setting of Thread Tension at Single Stitch	162
3 Operations on Prompt (P) Pattern	164
3.1 P Pattern Data Input	164
3.2 P Pattern Edition	166
3.3 P Pattern Copy	167
3.4 P Pattern Selection	168
3.5 P Pattern Sewing	170
4 Operations on Combination (C) Pattern	172
4.1 C Pattern Data Input	172
4.2 C Pattern Edition	173

4.3 C Pattern Selection.....	175
4.4 C Pattern Sewing.....	176
5 Pattern Edition.....	179
5.1 Have Access to Pattern Edition Mode.....	179
5.2 Pattern Edition.....	183
5.3 Quit Pattern Edition Mode	188
6 Information Functions.....	190
6.1 Maintenance & Repair Information	190
6.2 Input Time for Maintenance & Repair	191
6.3 How to Release Alarm	193
6.4 Production Control.....	193
6.4.1 Via Information Interface.....	194
6.4.2 Via Sewing Interface.....	195
6.4.3 Setting on Production Control.....	196
6.5 Display Threading Figure.....	200
6.6 Alarm Record.....	201
6.7 Running Record	202
6.8 Setting of Periodical Password.....	203
7 Communication Functions	210
7.1 About the Available Data	210
7.2 Operations	211
7.3 Pattern Transfer	211
7.4 Parameter Transfer	215
7.5 Software Update.....	217
8 Mode & Parameter Setting.....	219
8.1 List of Function Keys.....	219
8.2 Level 1 Parameters Setting.....	221
8.3 Level 2 Parameters Setting.....	228
8.4 Counter Setting	233
8.4.1 Functions.....	234
8.5 Change Sewing Mode	235

8. 6 Have Access to Pattern Edition	235
8. 7 Set Pattern Lock	236
8. 8 Initialization	236
8. 9 Software Version Inquiry	239
8. 10 Test Mode.....	239
8. 11 Keyboard Lock.....	247
8. 12 Parameter Back-up.....	249
8.13 Button-stitching Function Setting	249
8.14 Pattern Edition Parameter Setting	252
9 Controller System Principle	253
9.1 Structure of Control System.....	253
9.1.1 Installation Size of Control Box.....	253
9.1.2 Installation Size of Operation Box	253
9.1.3 The Control System Diagram.....	254
9.1.4 External Cable Connection of Control Box	257
9.2 List of Patterns in 1900A Controller	259
9.3 List of Patterns for Button-sewing in 1900B Controller	263
9.4 List of Patterns for Doubling Controller	264
9.5 List of Warning.....	268
9. 6 Hint List	271

1 概要说明

1.1 概述

本系列工业缝纫机电脑控制系统，主轴电机采用具有世界先进水平的交流伺服控制技术驱动，具有力矩大、效率高、车速稳定和噪音低等特点。操作面板设计多样化可满足不同客户的配套要求；系统采用德国式结构设计，安装和维修方便快捷，系统控制软件可通过远程通讯升级，方便用户不断提高产品性能。

1.2 技术参数表

序号	项 目	机 型 20X
1	用途	套结、钉扣
2	缝制范围	X(左右) 方向 40mm × Y(前后) 方向 30mm
3	最高缝纫速度	最高 3000rpm
4	最小缝制精度	0.1mm
5	送布	间接送布(脉冲马达 2 轴驱动方式)
6	针杆行程	41.2mm
7	机针	DP × 5 #14 (DP × 5 #11(F,M), (DP × 17#21 厚料))
8	抬压脚方式	脉冲马达
9	压脚上升量	标准 14mm, 最大 17mm(反转抬针时)
10	标准花样数	50/100 个
11	拨线方式	脉冲马达抬压脚连动
12	面线张力	电子夹线器
13	旋梭	半旋转标准旋梭或半旋转倍旋梭
14	加油方式	旋转部：微量加油
15	机油	缝纫机油
16	润滑脂	缝纫机用润滑脂
17	数据记忆	U 盘
18	放大缩小功能	X 方向、Y 方向各自独立缩放 20%~200% (1%单位)

19	放大缩小方式	线迹长度和针间距增减方式
20	缝制速度限制	400-3000rpm(100rpm 单位)
21	花样选择功能	花样号码指定方式(1-200)
22	底线记数	上转/下转方式(0 - 9999)
23	机械马达	500W 小型 AC 伺服马达(直接驱动方式)
24	外形尺寸	263mm×153mm×212mm
25	控制箱重量	约为 10 Kg
26	消耗电力	600W
27	使用温度范围	0℃~45℃
28	使用湿度范围	35%~85% (无结露)
29	电源电压	AC 220V ± 10%; 50/60Hz

※最高缝制速度请根据缝制条件降低速度使用

※产品执行标准：QCYXDK0004—2016《工业缝纫机计算机控制系统》。

1.3 安全使用注意事项

● 安装

- 控制箱
 - ◆ 请遵照说明正确装好
- 附件
 - ◆ 如要安装其它附件时，请先关掉电源并拔掉电源插头。
- 电源线
 - ◆ 请不要用重力去压住电源线或过度的扭曲电源线。
 - ◆ 请不要将电源线靠近转动的部位，最少要离开 25mm 以上。
 - ◆ 控制箱要接入电源前，请务必再查看要接入的电源电压是否与控制箱上标示的电压相同及确定位置后，才可供应电源。如有接用电源变压装置的话，同样的要检查一下后才可供应电源。这时缝纫机上的按钮式电源开关一定要放在 [OFF]。
- 接地
 - ◆ 为防止噪声干扰及漏电而发生电击事件，电源线上的接地线定要确实做好接地。
- 附属装置
 - ◆ 如要接用电气方面的附属装置的话，请遵照指示的位置接好。
- 拆卸
 - ◆ 要卸下控制箱时，必须要先关掉电源并拔掉电源插头。
 - ◆ 在拔离电源插头时不可只拉电源线，必须用手拿住电源插头拔出。
 - ◆ 控制箱里面有危险的高压电，所以要打开控制箱盖的话，需要先关掉电源后等候 5 分钟以上才可打开控制箱盖。

● 保养、检查和修理

- 修理和保养的作业，要请经过训练的技术人员执行。
- 更换机针和梭子时，请务必必要关电。
- 请使用正厂的零件。

● 其它的安全对策

- 缝纫机运转中请不要去触摸会转动和会移动的部位 (特别是机针和皮带附件)等，并注意头发不要靠近它们，以免发生危险。
- 控制装置不可摔落地，更不可在空隙间塞入其它物品。
- 请不要在拆掉各护盖的情形下运作。
- 如本控制装置有损伤或无法正常运作时，必要请有经验的技术人员调整，或检查修理，在故障还没排除前请不要再去运转它。
- 敬请各客户们不要自行改造或变更本控制装置。

● 废弃处理

- 请以一般产业废弃物处理。

● 警告示意和危险示意

- 错误的行为可能会发生危险，其程度如后述的标示区别说明。

 警告	错误的行动可能会发生重伤或死亡。	 注意	错误的行动可能会发生伤害或房屋或财产的损害。
---	------------------	---	------------------------

- 标示符号的表示如下说明。

	请遵照指示内容作业。		注意高压电 (电击) 的危险。
	注意高温。		务必接上接地线。
	绝对不要执行。		

1.4 使用上的预防措施

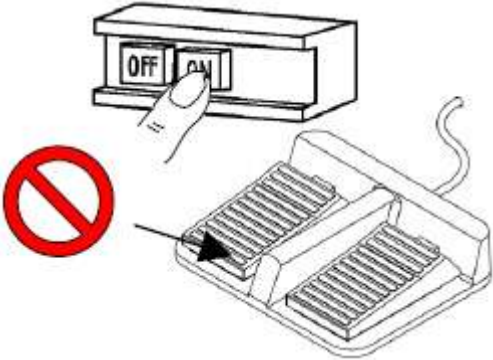
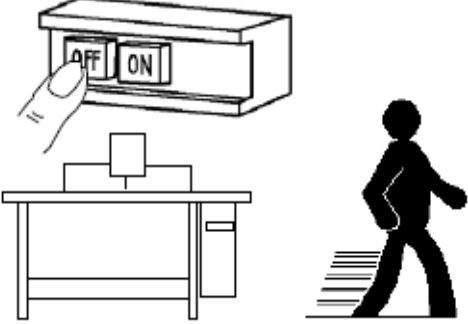
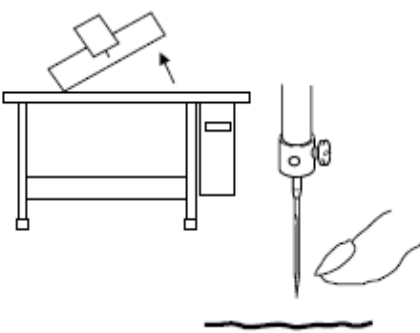
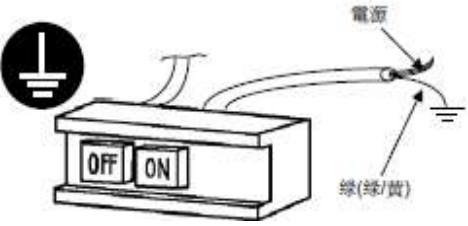
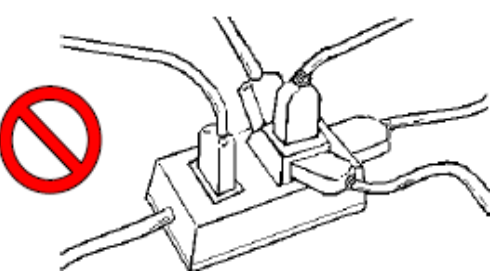
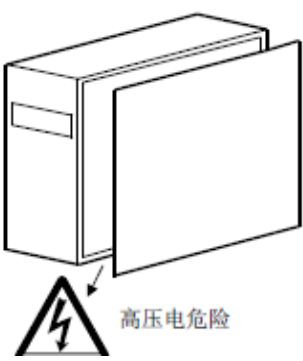

<p>1、当手要按开关 [ON] 时，脚定要离开脚踏板。</p> 	<p>2、要离开工作岗位时，请务必关掉电源。</p> 
<p>3、如要横倒头部或更换机针或穿面线时，请务必关掉电源。</p> 	<p>4、接地线要做好接地。</p> 
<p>5、不要用家庭用多插孔式延长线。</p> 	<p>6、控制箱内部存有危险的高压电，所以关掉电源后等候 5 分钟才可打开控制箱盖。</p> 
<p>7、更换电机后，请务必参照本资料所示设置主轴电机安装角度。</p>	
<p>8、请远离会产生高周波噪声干扰的机器。</p>	<p>9、如利用外接信号插座接应用附属装置时，其连接线长度请尽量越短越好，长线可能会导致误动作，连接线请用隔离线缆。</p>

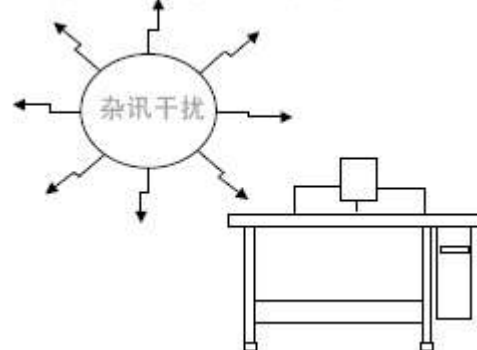
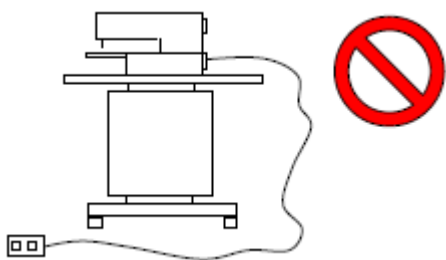
	
<p>10、如保险丝烧断时，请先把原因排除后再换相同容量的保险丝。</p>	

1.5 标准化

功能按键采用业界公认的图形标识，图形是国际化语言，各国用户都可以识别。

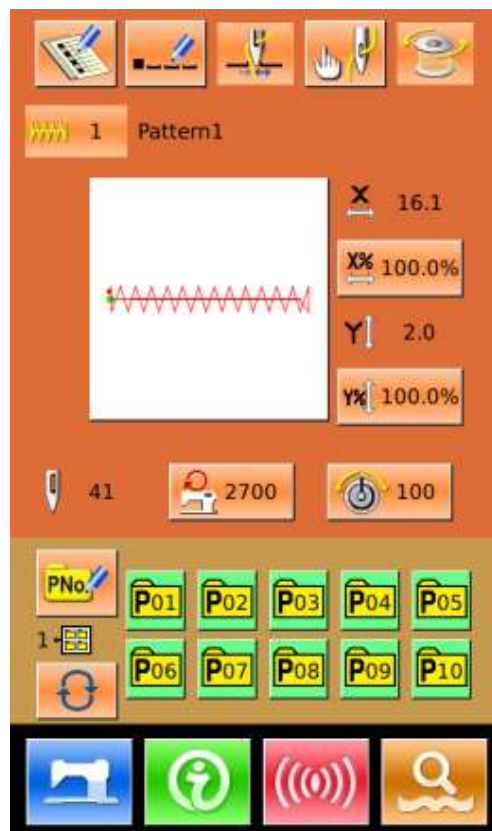

1.6 操作方式

本系统触摸屏操作面板采用了业界先进的触摸操作技术，友好的界面以及便捷的操控都给用户的日常使用带来革新性的变化。用户可以使用手指或者其他物体点触屏幕，完成相应的操作。用户在使用过程中应该注意避免使用尖锐的物体触碰屏幕，以免对触摸屏造成永久性损伤。

功能键包括准备键，信息键，模式键以及通信键等。具体操作方法参照后面章节的说明。



用户在使用过程中应该注意避免使用尖锐的物体触碰屏幕，以免对触摸屏造成永久性损伤。

2 操作说明

2.1 通用按键

在本系统的各界面上进行通用操作的按键如下：

序号	图标	功能
1		取消键 → 退出当前设定界面。数据变更界面时，取消变更中的数据。
2		确定键 → 确定变更了的数据。
3		加键 → 向上增加数值按键。
4		减键 → 向下减小数值按键。
5		复位键 → 解除异常。
6		输入键 → 显示数字键盘，可以进行数字的输入。
7		准备键 → 进行数据输入界面和缝制界面的切换。
8		信息键 → 进行数据输入界面和信息界面的切换。
9		通信键 → 进行数据输入界面和通信界面的切换。
10		模式键 → 进行数据输入界面和各种详细设定变换界面的切换。

2.2 基本操作

① 打开电源开关

打开电源之后，显示出数据输入界面。

② 选择想缝制的图案 No.

当前界面下会显示出已选择的图案No.，按下花样



显示按键之后可以选择图案No.。

有关花样选择的操作，详见【2.7花样选择】一节。

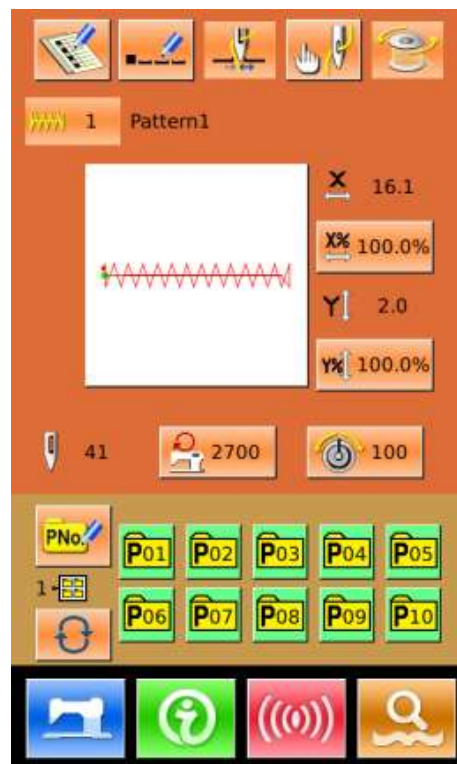

③ 设定成可以缝制的状态

按准备键之后，液晶显示的背景颜色变为蓝色，变成可以缝制的状态。

④ 开始缝制

把缝制品安放到压脚部，踩踏板落下压脚，缝纫机启动，开始进行缝制。

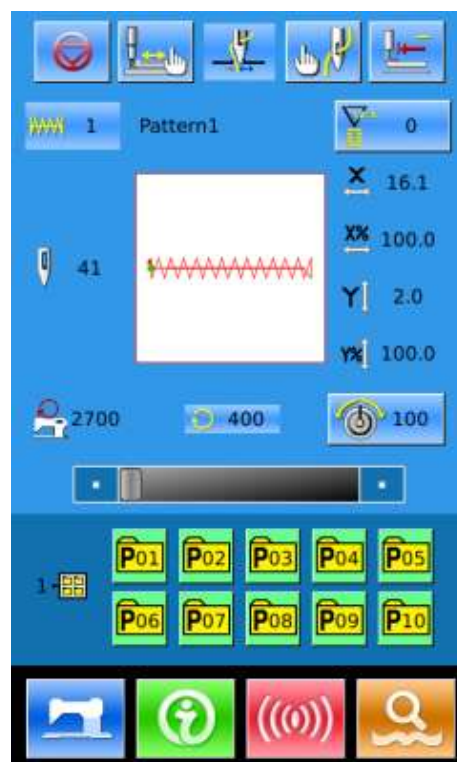

2.3 普通花样操作

(1) 缝制数据输入界面

数据输入界面如右图所示，详细功能说明请见功能键说明表。

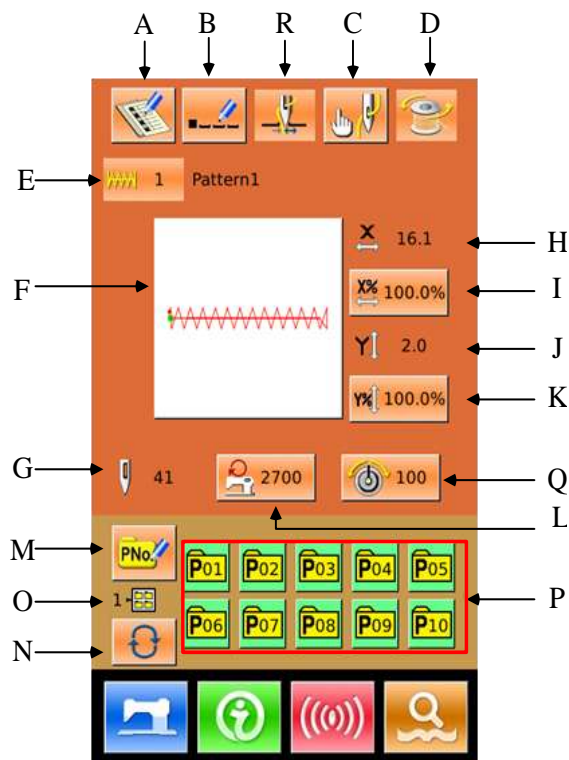

功能说明:

序号	功能	内容
A	花样登记	可以登记 999 个普通花样。
B	花样命名	最多可以输入 14 个字符。
R	抓线按键 (根据实际机械配置显示该案件)	选择抓线的有效/无效。受 U35 参数影响。
C	穿线	下降压脚，显示出下降压脚画面。让压脚上升，请按下降压脚画面上显示的上升压脚按键。
D	绕线	按下一次准备键  之后方可绕线。
E	花样号码显示	显示当前选择花样号码。
F	缝制形状选择	按键上显示为当前花样缝制形状，按下之后进入花样选择界面。
G	花样针数显示	显示当前选择花样缝纫针数。

H	X 实际尺寸值显示	显示当前选择花样的 X 方向实际尺寸值。 通过参数 U64 可以选择输入实际尺寸，此时显示出 X 实际尺寸值按钮。
I	X 放大缩小率设定	按钮上显示当前选择花样的 X 方向放大缩小率，按下之后进入设置界面。受参数 U64 和 U88 影响。
J	Y 实际尺寸值显示	显示当前选择花样的 Y 方向实际尺寸值。 通过参数 U64 可以选择输入实际尺寸，此时显示出 Y 实际尺寸值按钮。
K	Y 放大缩小率设定	按钮上显示当前选择花样的 Y 方向放大缩小率，按下之后进入设置界面。受参数 U64 和 U88 影响。
L	最高转速限制	显示最高转速限制值，按下之后可进行设置。
M	快捷花样（简称 P 花样）登记	用于登记 P 花样，最多登记 50 个。
O	P 花样文件夹号码显示	显示当前 P 花样文件夹号码。
N	P 花样文件夹选择	顺序切换 P 花样文件夹号码。
P	P 花样选择	显示出已登记的 P 花样，按下之后进入 P 花样数据输入界面。 初期状态不显示该按钮。
Q	线张力设定(根据实际的机械配置显示该按钮)	显示线张力的基准值，按下之后进行设置。

(2) 缝制界面

按下  进入缝制界面如右图所示。详细功能说明请见功能键说明表。

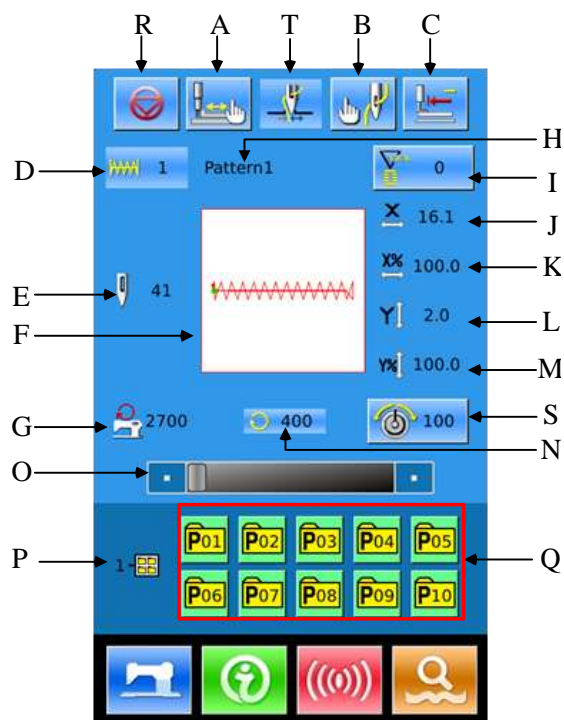

功能说明:

序号	功能	内容
A	试缝	按下后进入试缝界面，可以确定花样形状。
T	抓线按键 (根据实际的机械配置情况显示该按键)	选择抓线的有效/无效。受 U35 参数影响。
B	压脚下降按键	下降压脚，显示出下降压脚画面。让压脚上升时，请按下降压脚画面上显示的上升压脚按键。
C	原点复位	按下后压脚返回起缝点，上升压脚
D	花样号码显示	显示当前选择花样号码。
E	花样针数显示	显示当前选择花样缝纫针数。



F	花样形状显示	显示当前选择花样形状。
G	最高转速限制显示	显示最高转速限制值。
H	花样名称	显示当前选择花样名称。
I	计数器设置	按下后可以选择计数器类型和设置当前计数值。  : 缝制计数器  : 计件计数器
J	X 实际尺寸值显示	显示当前选择花样的 X 方向实际尺寸值。
K	X 放大缩小率设定	显示当前选择花样的 X 方向放大缩小率。
L	Y 实际尺寸值显示	显示当前选择花样的 Y 方向实际尺寸值。
M	Y 放大缩小率设定	显示当前选择花样的 Y 方向放大缩小率。
N	缝纫速度显示	显示当前缝纫速度。
O	缝纫速度设置	可以变更缝纫速度。
P	P 花样文件夹号码显示	显示当前 P 花样文件夹号码。
Q	P 花样选择	显示出已登记的 P 花样，按下之后进入 P 花样缝制界面。初期状态不显示该按钮。
R	暂停按钮	按下后机器停止运转。 受参数 U31 的影响，选择面板暂停按钮选项，显示暂停键，其他选项不显示。
S	线张力设定 (根据实际的机械配置 情况显示该按钮)	显示线张力的基准值，按下之后进行设置。

2.4 花样登记

最多可以登记普通花样 999 个。按下  进入花样登记界面（如右图所示）：

① 输入花样号

通过数字键可以选择想要输入的花样号码，如果输入了已经存在的花样号码，界面上方会显示出被登记的缝制形状及相关数据。通过

过 、 键可以检索未登记的花样号码。

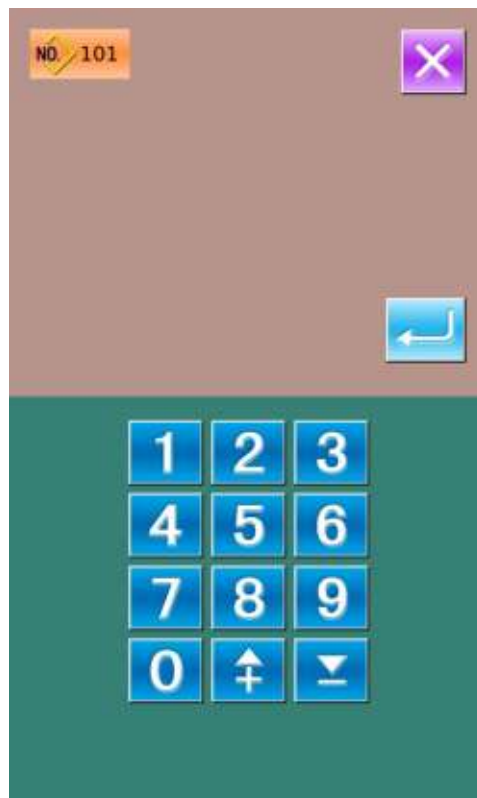

② 登记新花样

确定花样号码后按下 ，之前显示花样数据会复制到新登记花样中，操作结束后返回到新登记花样数据输入界面。

如果输入了已经存在的花样号码会提示是否覆盖已存花样。

注：基础花样不能被覆盖。

2.5 花样命名

按下  进入花样命名界面（如右图所示），最多可以输入 14 个字符。

 : 光标右移键

 : 光标左移键

 : 字母大小写切换键

 : 清除键

选择想要输入的字符，按下  结束花样命名操作。

通过移动光标可以确定该字符位置，清除键可以消除该位置字符。

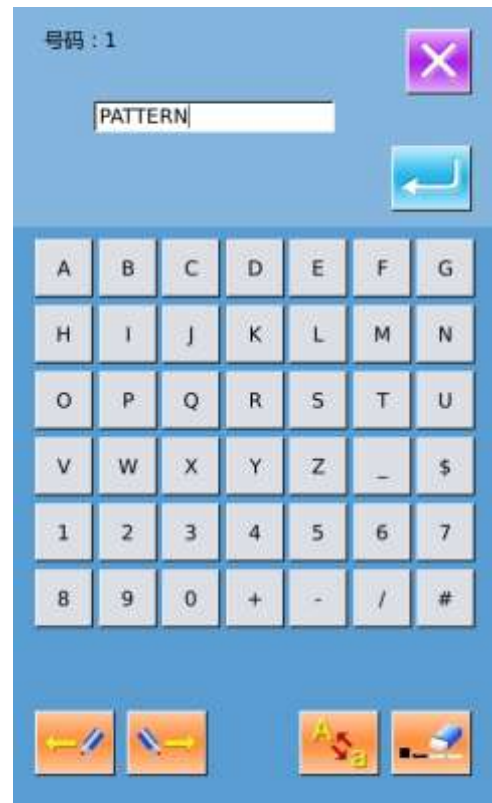

2.6 绕线

① 安装梭芯

把梭芯插进绕线轴。如右图所示。

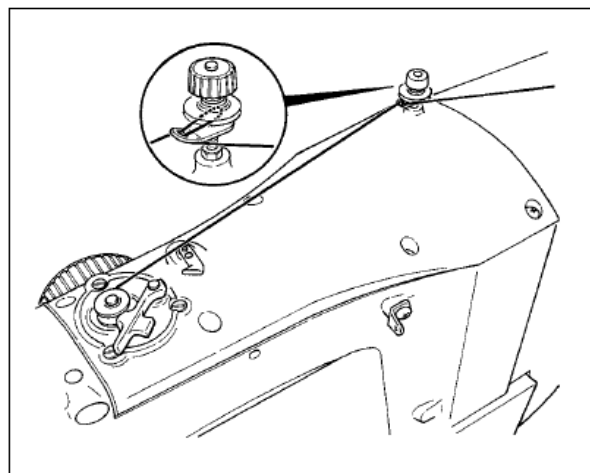

② 显示底线绕线界面

在数据输入界面上，按了绕线按键





之后，绕线界面被显示出来（如右图所示）。

③ 开始绕线

踩踏启动踏板之后，缝纫机转动，开始卷绕底线。

④ 停止缝纫机

按了停止按键  之后，缝纫机停止转动，返回通常模式。另外，在卷绕底线中再次踩踏踏板之后，缝纫机在绕线模式下停止缝纫机，因此再次踩踏启动踏板，可以继续卷绕底线，在卷绕多个梭芯时可以利用此功能。

注：刚刚打开电源后，或者刚刚变更为主机输入后，不进行卷线动作。请设定1次图案花样，按准备键  之后显示出缝制画面。

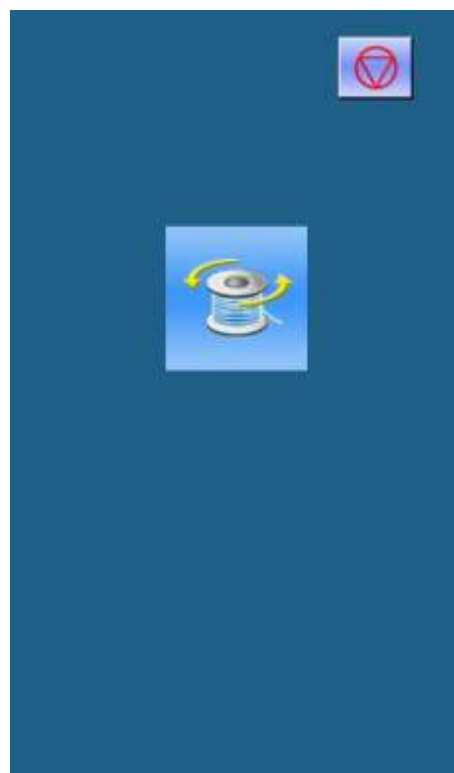

2.7 花样选择

① 进入花样选择界面

数据输入界面（如右图所示），点击缝制形状 A 之后进入花样选择界面。

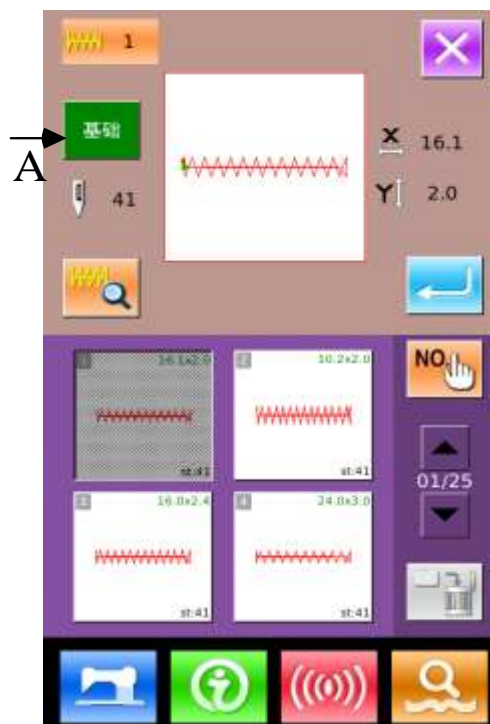
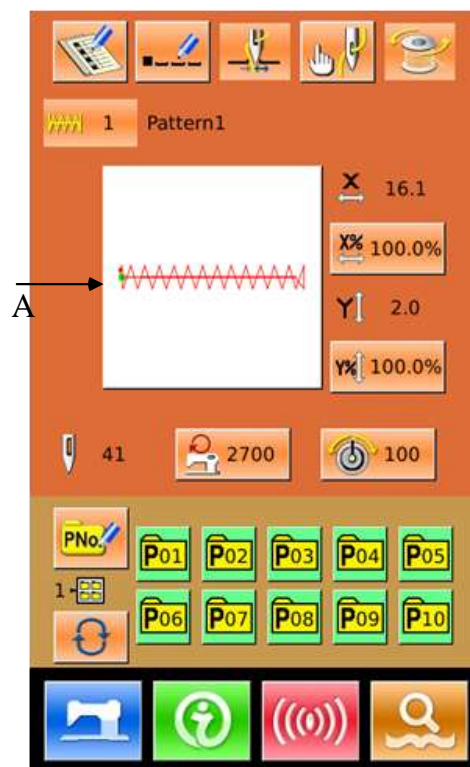

花样选择界面上方为当前选择花样的缝制形状，下方为已登记的花样号码。

：花样预览

：输入号码查询花样

：花样删除

点击 **A** 键，当存在普通花样时，会在基础花样和用户花样之间来回切换。

② 选择花样

当前为基础花样时，每页可以显示4个花样号码；自编花样时，每页可显示20个花样号码。针对基础花样，每个花样号码上显示出该花样的简图和x、y范围；自编花样只显示花样号码。选中已登记的花样号码时，上方会显示已选择花样内容，按下  完成花样选择操作。

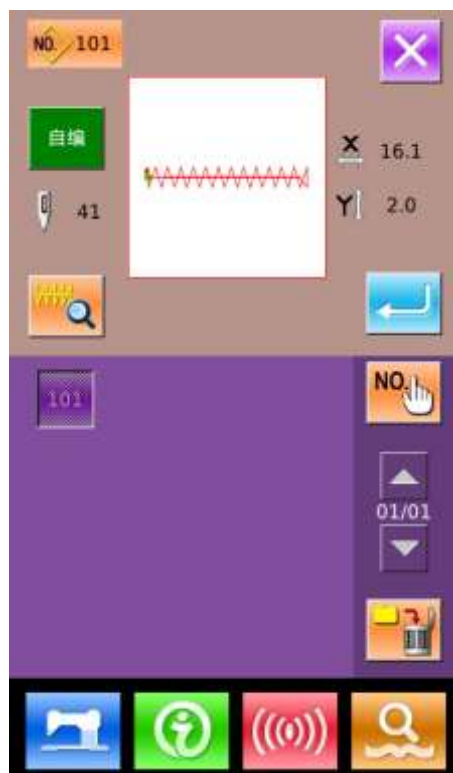

③ 花样查询

按下  键会弹出花样查询界面，通过数字键可以直接输入花样号码。

④ 花样删除

选中已登记的花样，按下  键就会删除掉该花样，但是被登记到 **P** 的花样是不能被删除的。
注：花样分为基础花样和普通花样：基础花样为出厂花样，不能被删除；普通花样为用户打版、复制或U盘导入的花样，花样可以被删除和修改。

⑤ 花样预览

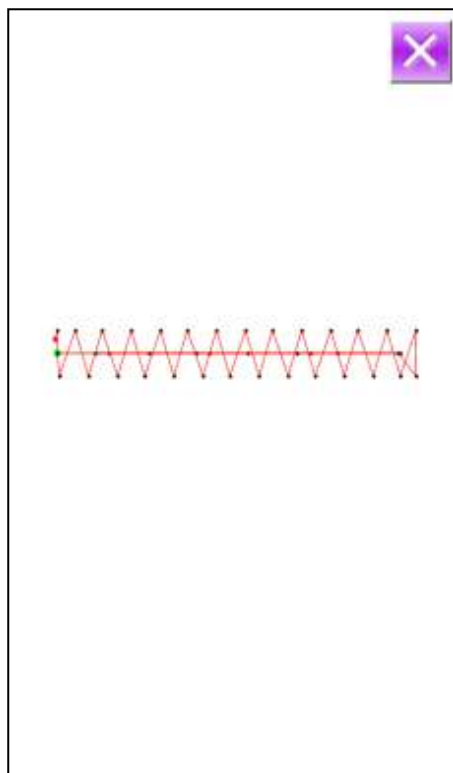

按下  键可以全屏预览当前花样形状。（背景为白色）

2.8 缝纫数据设定

① 进入缝纫数据设定界面

在数据输入界面下相应按下 A、B、C 可分别进入缩放率设置和速度限制设置界面。

	项目	输入范围	初始值
A	X 方向 放大缩小率	1.0~400.0%	100.0%
B	Y 方向 放大缩小率	1.0~400.0%	100.0%
C	最高速度限制	400~2700rpm(各机型上限不同)	2700rpm

注 1: 参数 U64 可以切换选择设置放大缩小率或实际尺寸值。

注 2: 最高速度限制的最大输入范围和初始值受参数 U01 影响。

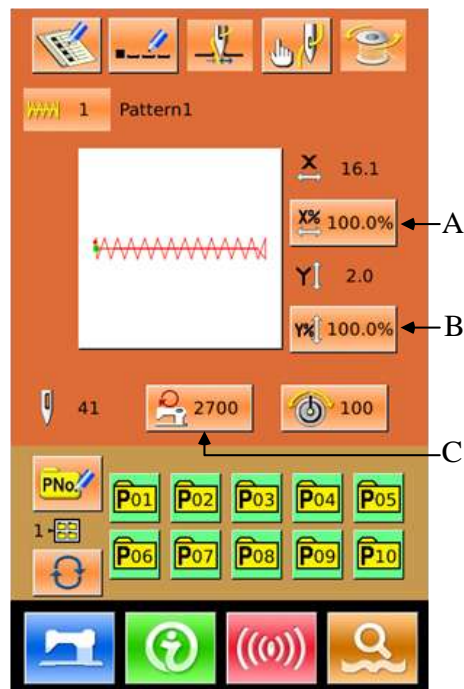

② 缩放率设定

右图为放大缩小率设定界面，界面上方为X方向设置，下方为Y方向设置。

A: X方向实际值显示

B: X方向放大缩小率显示

C: Y方向实际值显示

D: Y方向放大缩小率显示

通过 **0** ~ **9** 十数字键盘或 **↑**、**↓** 键输入希望值，被输入的数字插入到显示数值的第一位，以前输入的数字一位一位的累进，按下确定键 **↵** 完成操作返回数据输入界面。

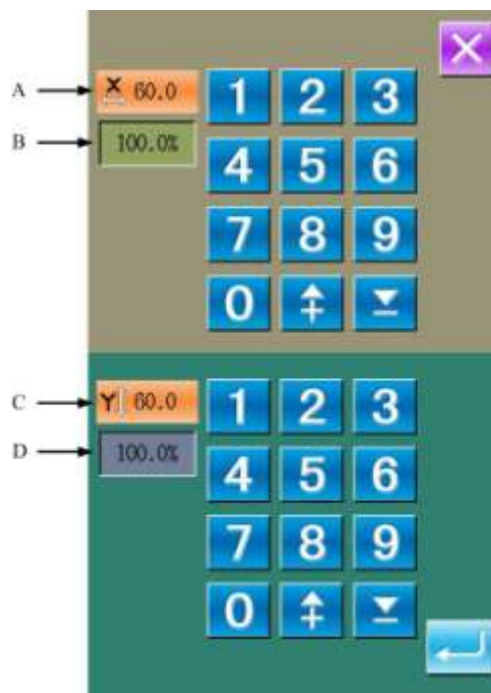

③ 最高速度限制设定

操作同上。







2.9 P 花样登记

① 进入 P 花样登记界面

在数据输入界面下按下  进入 P 花样登记界面，如右图。

② 输入 P 花样号码

通过  ~  十数字键盘或 、 键输入想要登记的号码，如果输入了已经登记的花样号码，界面上方会显示出被登记的缝制形状和相关数据，这种情况下是不能登记新花样的。

③ 选择文件夹号码

P 花样号码可以登记到 5 个文件夹里，每个文件夹最多保存 10 个 P 花样。文件夹选择键  可以进行顺序选择。

④ 确定花样号码

按下确定键  之后完成 P 花样登记操作，返回到 P 花样数据数据输入界面。



2.10 试缝操作

① 显示缝制界面

在数据输入界面，按准备键  之后，液晶显示的背景颜色变为蓝色，此时进入缝制界面。



② 显示试缝界面

在缝制界面下，按下  键后进入试缝界面（如右图所示）：

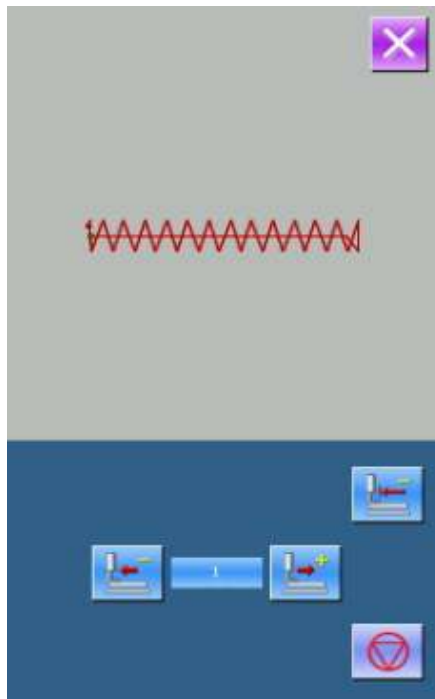
- ：返回原点
- ：压脚后退
- ：压脚前进
- ：停止





③ 开始试缝

踩下脚踏开关下降压脚，用压脚后退键  和压脚前进键  确定形状。持续一段时间连续按键后，离开按键后压脚继续移动，想停止时按下  键。



按下返回原点键  后，机针返回原点且返回到缝制界面。

④ 结束试缝

按了取消键  退出试缝界面之后，返回缝制界面。花样形状没有在开始缝制位置或结束缝制位置时，踩脚踏开关后，可以从确认中途进行缝纫。如要退出则按下原点复位键  之后，关闭凸起画面，显示出缝制画面，返回开始缝制位置。.

2.11 计数器操作

① 显示计数器界面

在缝制界面中，按了  () 键之后，计数器设定界面被显示出来。





: 缝制计数器类型

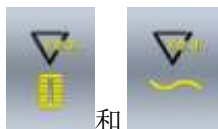

: 计件计数器类型

② 选择计数器类型并设定计数值



通过选择  和  可以设置计数器类型，并且设置其当前计数值。



2.12 急停

通过设定 U31 参数来选择暂停方式：

可通过无效、操作盘暂停按键、外部开关三种选项来选择。

当选择操作盘暂停键之后，在缝制画面上显示出暂停按键

。

① 解除异常

在缝制中按了暂停键之后，可以停止缝纫机转动。此时异常画面被显示，通知停止开关被按下。

此时按下复位键  解除异常。

② 进行切线

按下切线键  之后，可以进行切线，进入到步骤设置界面。

注：参数 U97 设为暂停后自动切线时直接进入步骤设置。





② 进行步骤设置，调整压脚到重新缝纫位置

按下切线键  进入到步骤设置界面。

 : 后退送布

 : 前进送布

 : 原点复位

按下  或  ，移动压脚到重新缝纫位置。

③ 重新缝纫

踩下脚踏板之后，重新启动缝纫。

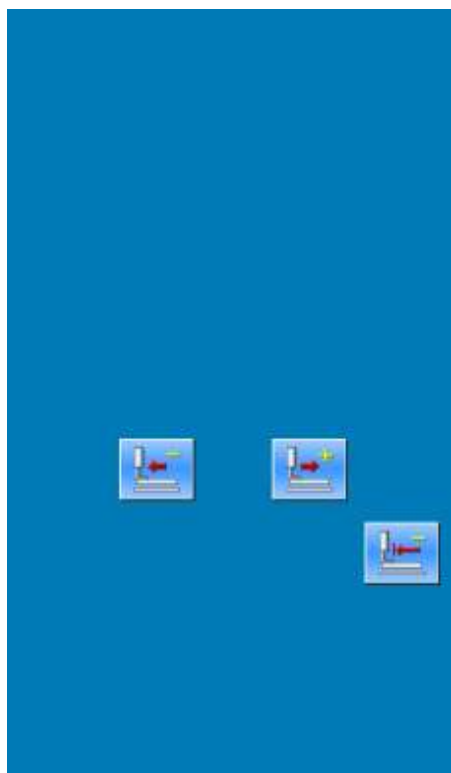

2.13 单针线张力设置

① 进入单针线张力设置

在运行界面(如右图), 点击线张力设定 (A) 进入线张力设置界面。

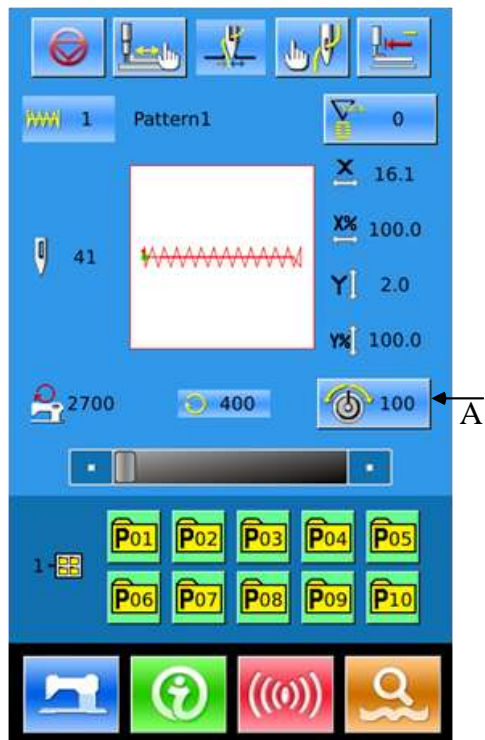



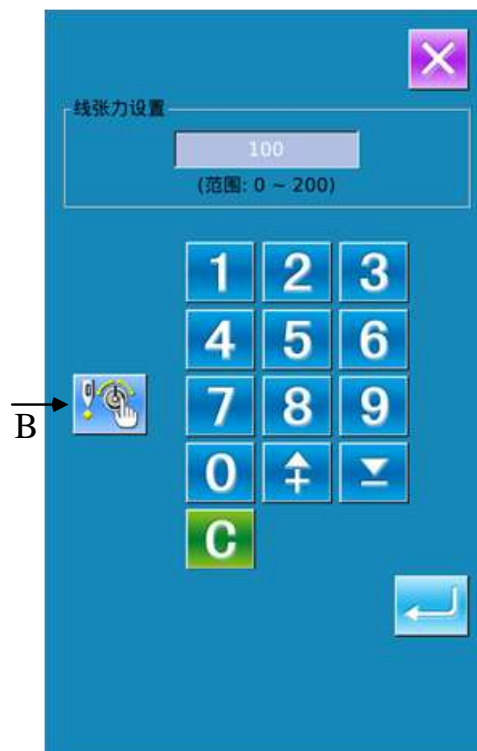

在线张力设置界面(如右图), 点击单针线张力设置 (B) 进入单针线张力设置界面。



② 单针线张力设定

点击  之后，进入线张力设置界面。设置方法同 2.5 方法相同。

在外压脚下降的状态下，用  和  前进或后退一针。用  和  向后或向前移动到有线张力命令的落针点。想要停止时，按下 。

按下返回原点  之后，移动到原点。

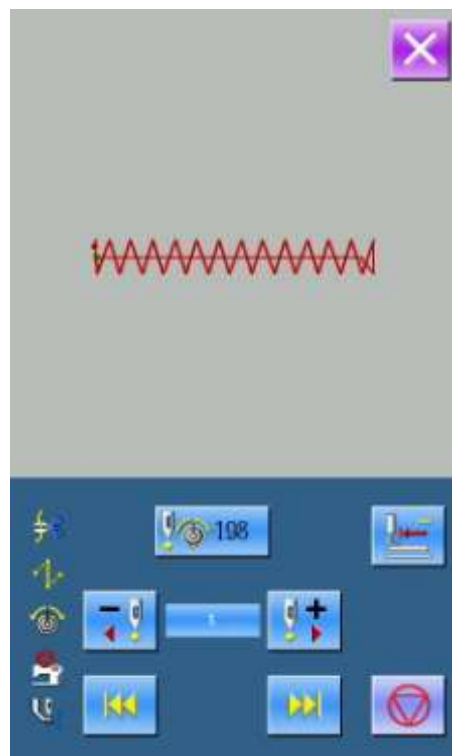

3 快捷 (P) 花样操作

3.1 P 花样数据输入

快捷花样简称 P 花样，由一个普通花样和相关花样缝制参数 (X 缩放率、Y 缩放率、速度限制等) 组成。选用 P 花样不需要每次设置相关参数。

P 花样数据输入界面如右图所示。

最多可以登记 50 个 P 花样。

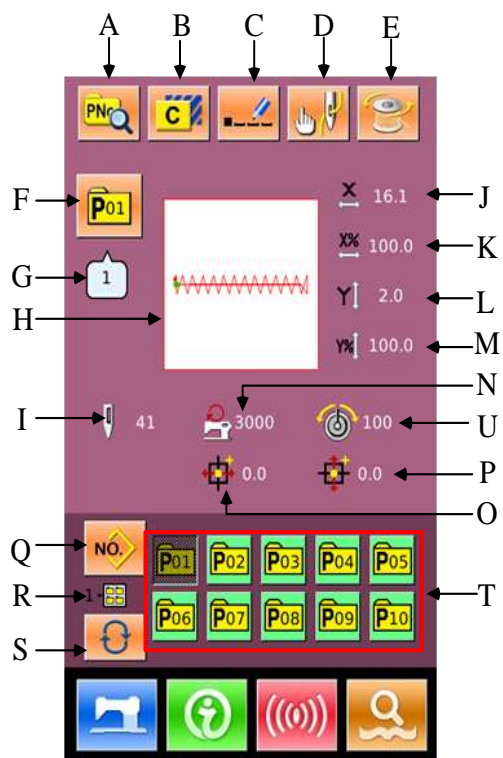

功能说明:

序号	功能	内容
A	P 花样编辑	可以编辑 P 花样内容。
B	P 花样复制	可以复制当前 P 花样内容到一个空花样号码下。
C	花样命名	最多可以输入 14 个字符。
D	穿线	按下之后外压脚下降。
E	绕线	按下一次准备键  之后方可绕线。
F	P 花样号码显示	显示当前选择花样号码。
G	缝纫形状号码显示	显示当前 P 花样下引用的普通花样号码。

序号	功能	内容
H	缝制形状选择	显示为当前花样缝制形状。
I	花样针数显示	显示当前选择花样缝纫针数。
J	X 实际尺寸值显示	显示当前选择花样的 X 方向实际尺寸值。
K	X 放大缩小率设定	显示当前选择花样的 X 方向放大缩小率。
L	Y 实际尺寸值显示	显示当前选择花样的 Y 方向实际尺寸值。
M	Y 放大缩小率设定	显示当前选择花样的 Y 方向放大缩小率。
N	最高转速限制	显示最高转速限制值。
O	X 方向偏移量显示	显示当前选择花样的 X 方向偏移量。
P	Y 方向偏移量显示	显示当前选择花样的 Y 方向偏移量。
Q	返回普通花样数据输入	返回到普通花样数据输入界面。
R	P 花样文件夹号码显示	显示当前 P 花样文件夹号码。
S	P 花样文件夹选择	顺序切换 P 花样文件夹号码。
T	P 花样选择	显示出已登记的 P 花样。
U	线张力值	显示花样的线张力基准值

3.2 P 花样编辑

① 进入 P 花样编辑界面

按下  进入P花样编辑界面（如右图所示）。

② 编辑项目数据变更

选择想要变更的项目，设置数值。

	项目	输入范围	初始值
A	缝制形状		
B	文件夹号码	1~5	
C	最高速度限制	400~3000rpm	3000rpm
D	X方向偏移量	-30.0~30.0mm	0
E	X方向放大缩小率	1.0~400.0%	100.0%
F	Y方向放大缩小率	1.0~400.0%	100.0%
G	Y方向偏移量	-30.0~30.0mm	0
H	线张力值	0~200	100

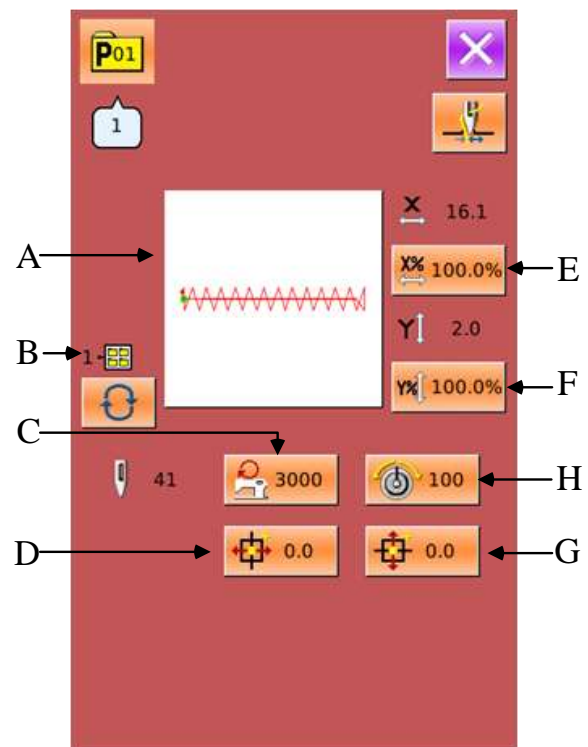

③ 确定数据变更

以设置X方向偏移量为例，通过  ~

 十数字键盘或 、 键输入

数值，按下确定键  完成操作。

：代表正数值；

：代表负数值。

④ 退出编辑

按下退出键  关闭P花样编辑界面，返回数据输入界面。



3.3 P 花样复制

① 选择被复制花样

按下  进入P花样复制界面（如右图所示）。在已登记的花样中选择被

复制花样号码并按下 。

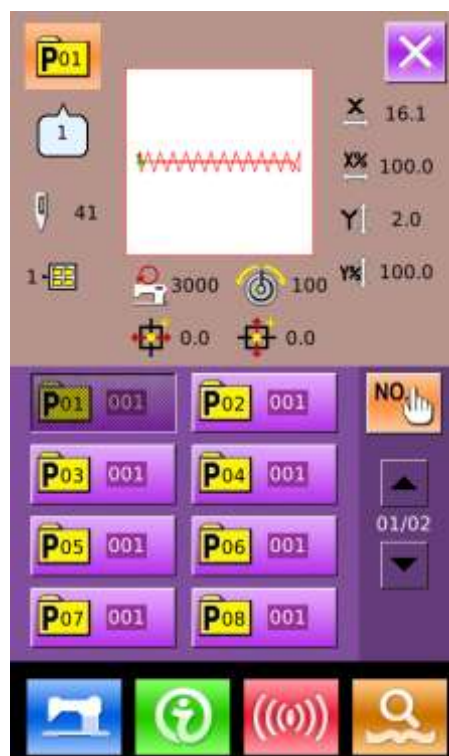

② 输入新登记的花样号码

界面上方显示为被复制花样，通过数字键选择未登记的花样号码，已经登记的花样号码不能重复登记。

文件夹选择键  可以选择保存的

文件夹。按下确定键  则完成花样复制操作，返回到P花样复制界面。

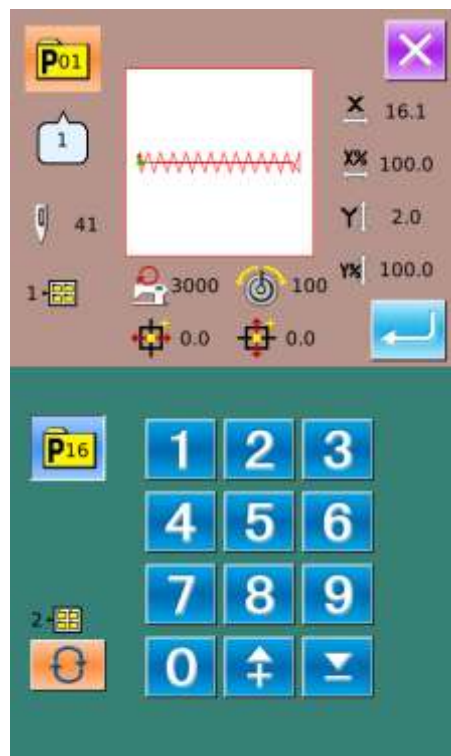

3.4 P 花样选择

① 进入 P 花样选择界面

如右图所示，按下图标 A，可以进入 P 花样选择界面。

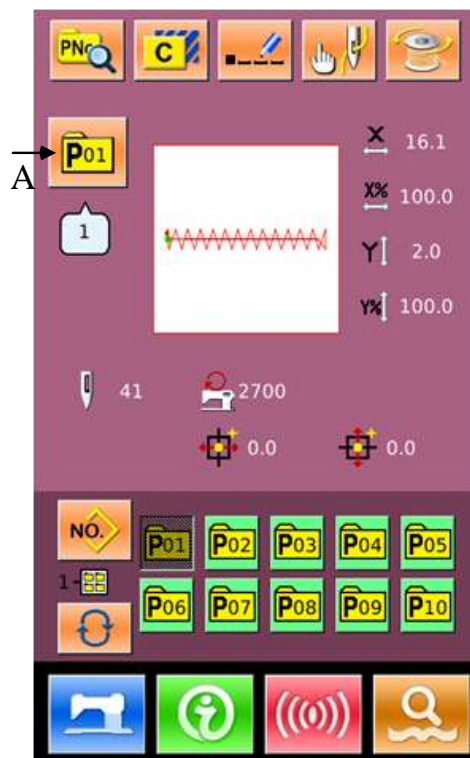

② 选择花样号码

界面上方为当前选择花样信息，当按下文件夹选择键  切换到文件夹号码不显示时，可以把已登记的P花样全部显示出来。

③ 确定花样选择

操作同普通花样选择，按下确定键  结束选择。

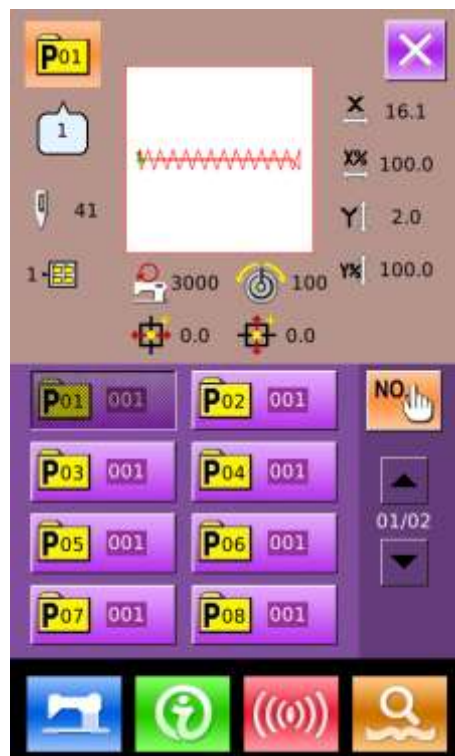

3.5 P 花样缝制

在 P 花样数据输入界面下，按下  进入缝制界面（如右图所示）。

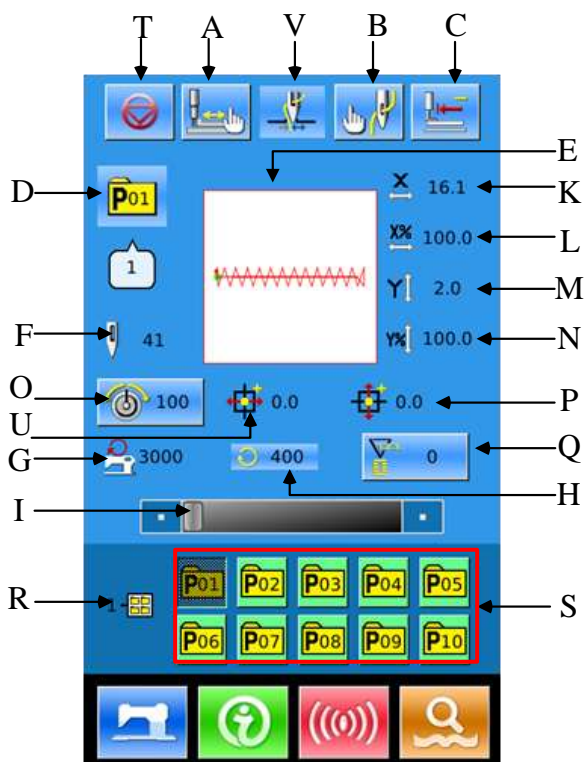

功能说明：

序号	功能	内容
----	----	----

序号	功能	内容
A	试缝	按下后进入试缝界面，可以确定花样形状。
B	穿线	按下之后外压脚下降。
C	原点复位	按下后压脚返回始缝点。
D	P 花样号码显示	显示当前选择花样号码。
E	缝纫形状号码显示	显示当前 P 花样下引用的普通花样号码。
F	花样针数显示	显示当前选择花样缝纫针数。
G	最高转速限制显示	显示最高转速限制值。
H	缝纫速度显示	显示当前缝纫速度。
I	缝纫速度设置	可以变更缝纫速度。
K	X 实际尺寸值显示	显示当前选择花样的 X 方向实际尺寸值。
L	X 放大缩小率设定	显示当前选择花样的 X 方向放大缩小率。
M	Y 实际尺寸值显示	显示当前选择花样的 Y 方向实际尺寸值。
N	Y 放大缩小率设定	显示当前选择花样的 Y 方向放大缩小率。
O	X 方向偏移量显示	显示当前选择花样的 X 方向偏移量。
P	Y 方向偏移量显示	显示当前选择花样的 Y 方向偏移量。
Q	计数器设置	按下后可以选择计数器类型和设置当前计数值。  : 缝制计数器  : 计件计数器
R	P 花样文件夹号码显示	显示当前 P 花样文件夹号码。
S	P 花样选择	显示出已登记的 P 花样。
T	暂停按键	按下后机器停止运转。 受参数 U31 的影响，选择面板暂停按键选项，显示

序号	功能	内容
		暂停键，其他选项不显示。
U	线张力值设定	按下后进入线张力设置界面。
V	抓线按键	选择抓线的有效/无效。受 U35 参数影响。

4 组合 (C) 花样操作

4.1 C 花样数据输入

组合花样简称 C 花样，由一组 P 花样组成，
每组 C 花样可以输入最多 50 个子花样。一共
可以登记最多 50 组 C 花样。

参照【8.8 变换缝制类型】一节内容进入组合
花样数据输入界面，如右图所示。

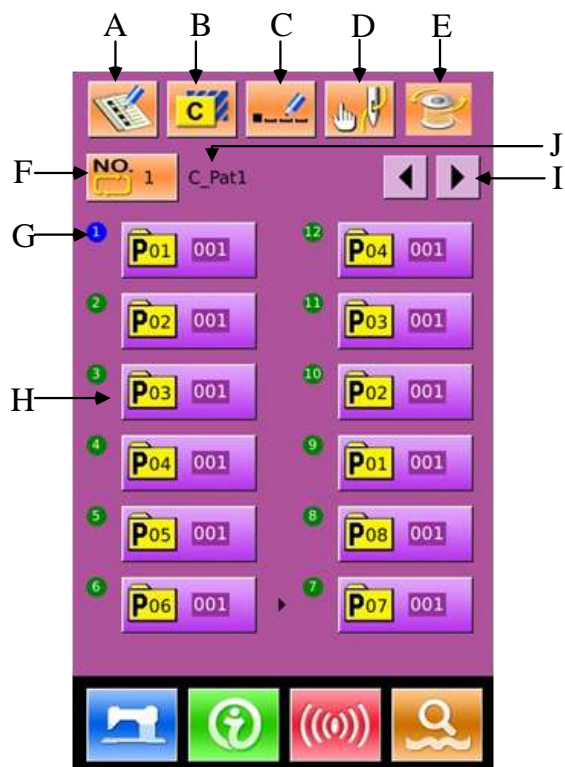

功能说明:

序号	功能	内容
A	C 花样登记	登记一个新组合花样。
B	C 花样复制	可以复制当前 C 花样内容到一个空花样号码下。
C	花样命名	最多可以输入 14 个字符。
D	穿线	按下之后外压脚下降。
E	绕线	按下一次准备键  之后方可绕线。
F	C 花样号码选择	按键上显示当前选择花样号码，按下后进入 C 花样选择界面。

序号	功能	内容
G	缝制顺序显示	显示当前选择花样的缝制顺序，蓝色显示为起始缝制图案。
H	C 花样图案选择	按下后进入 C 花样编辑界面，可以选择输入一个 P 花样。
I	翻页键	C 花样图案最多可以登记 30 个，每页最多显示 6 个图案。
J	C 花样名称	显示 C 花样名称。

4.2 C 花样编辑

① 进入 c 花样编辑界面

在 C 花样数据输入界面下，按下 A 可以进入 C 花样编辑界面。

在初期状态下，没有登记到 P 花样做为缝制图案，因为第一个图案以空白状态显示。

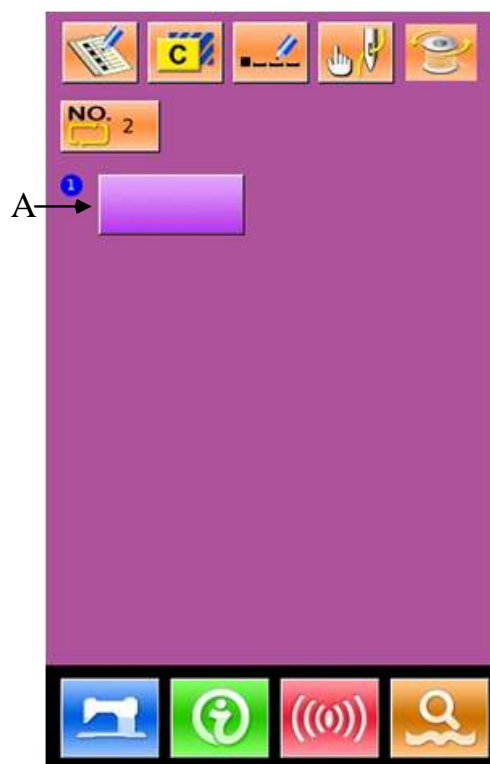

② 选择图案

右图为 C 花样编辑界面，选择想要登记的 P 花样图案 B，按下确定键之后结束选择。

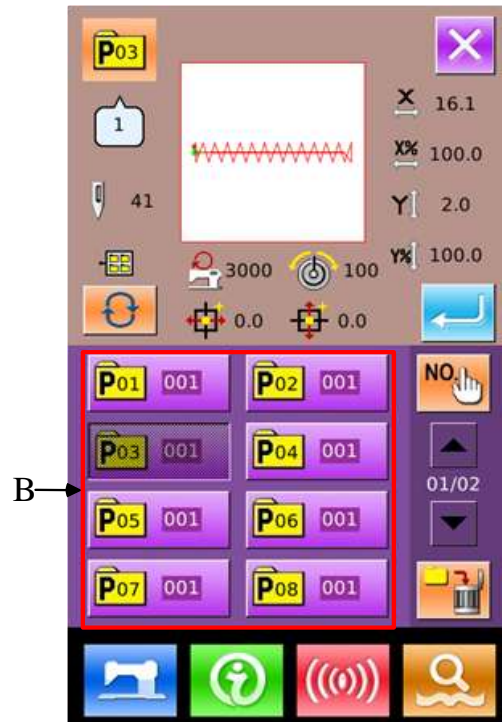

③ 反复登记剩余图案

第一个图案登记确定之后，第二个图案选择键 C 被显示出来，操作同上，可以反复登记其它剩余图案。

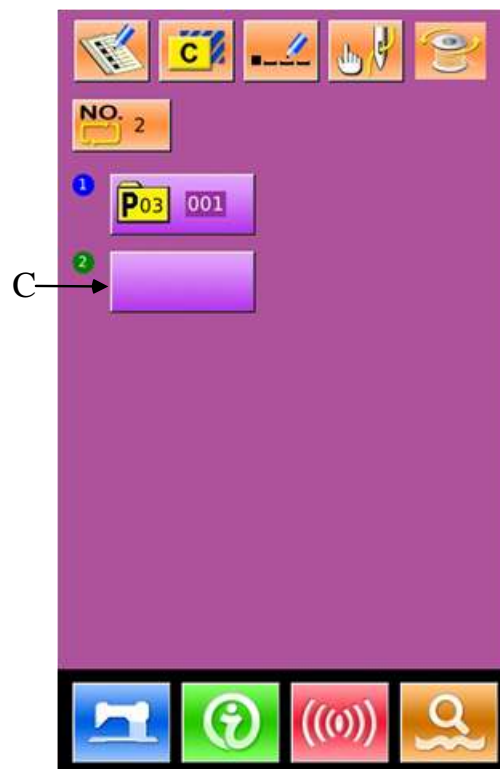

4.3 C 花样选择

① 进入 c 花样选择界面

如右图所示，按下图标 A，可以进入 C 花样选择界面。

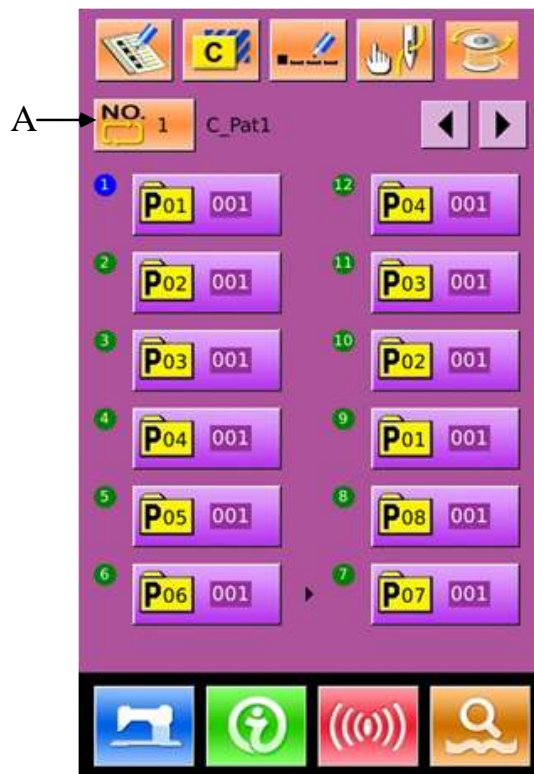

② 选择 c 花样号码

右图为 C 花样选择界面，按下 B 键之后，可以顺序变换当前 C 花样下输入的 P 子花样数据信息。

确定要选择的 C 花样号码键 C，按下确定键  之后结束选择。

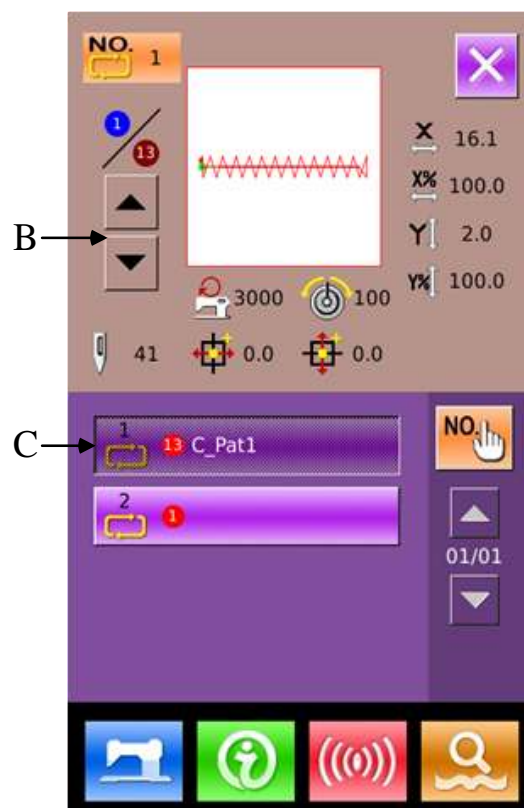

4.4 C 花样缝制

在 C 花样数据输入界面下，按下  进入缝制界面（如右图所示）。

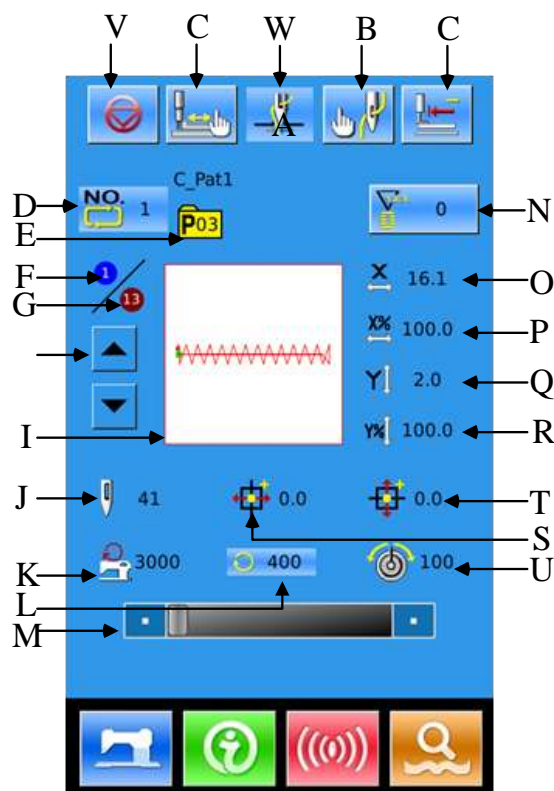

功能说明：

序号	功能	内容
A	试缝	按下后进入试缝界面，可以确定花样形状。
B	穿线	按下之后外压脚下降。
C	原点复位	按下后压脚返回始缝点。
D	C 花样号码显示	显示当前选择 C 花样号码。
E	缝纫形状号码显示	显示当前 C 花样下登记的子花样号码。
F	缝制顺序显示	显示当前缝制花样中的缝制顺序号
G	登记总数显示	显示当前 C 花样所登记的子花样总数

序号	功能	内容
H	缝制顺序前进/后退键	可以把缝制图案选择到后一个/前一个。
I	花样形状显示	显示当前缝制所登记的形状。
J	花样针数显示	显示当前缝纫登记形状针数。
K	最高转速限制显示	显示当前缝纫登记形状最高转速限制值。
L	缝纫速度显示	显示当前缝纫速度。
M	缝纫速度设置	可以滑动变更缝纫速度。
N	计数器设置	按下后可以选择计数器类型和设置当前计数值。  : 缝制计数器  : 计件计数器
O	X 实际尺寸值显示	显示当前缝纫登记形状的 X 方向实际尺寸值。
P	X 放大缩小率设定	显示当前缝纫登记形状的 X 方向放大缩小率。
Q	Y 实际尺寸值显示	显示当前缝纫登记形状的 Y 方向实际尺寸值。
R	Y 放大缩小率设定	显示当前缝纫登记形状的 Y 方向放大缩小率。
S	X 方向偏移量显示	显示当前缝纫登记形状的 X 方向偏移量。
T	Y 方向偏移量显示	显示当前缝纫登记形状的 Y 方向偏移量。
U	线张力显示	显示线张力基准值。
V	暂停按键	按下后机器停止运转。 受参数 U31 的影响, 选择面板暂停按键选项, 显示暂停键, 其他选项不显示。
W	抓线按键	选择抓线的有效/无效。受 U35 参数影响。

5 花样图案编辑

5.1 进入花样编辑模式

按下  可以切换数据输入界面和模式选择界面（如右图所示），在该界面下可以进行一些详细的设置和编辑操作。



有关模式选择界面下的详细操作和设置详见【8 模式和参数设置】。

按下 ，会与  互相切换。

：缝纫模式

：编辑模式

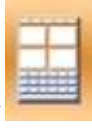

选择编辑模式图标 ，再次按下  键后，退出模式选择界面，系统提示是否进入花样编辑界面。

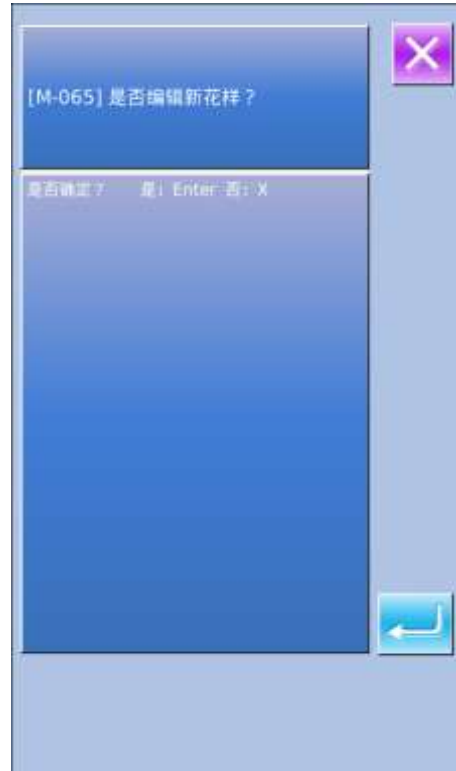

按下  后，进入花样编辑标准界面，如右图所示：

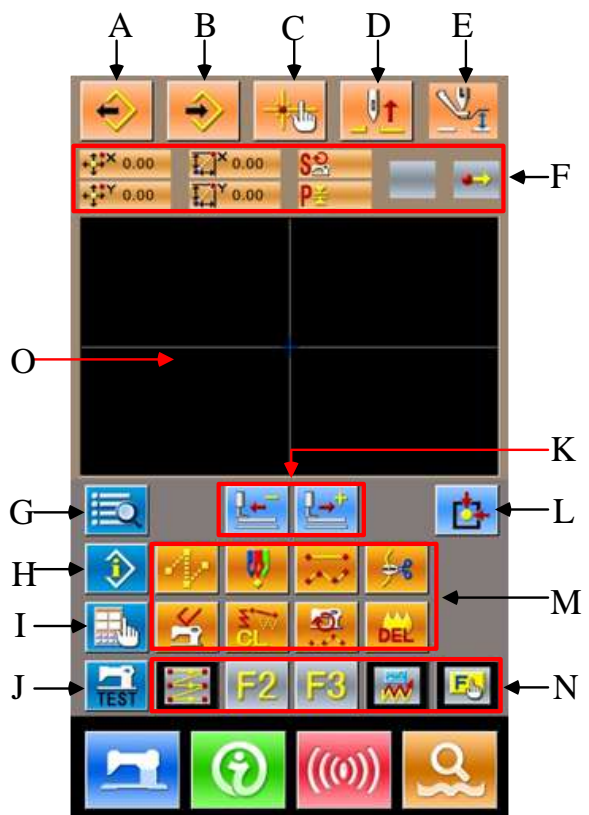







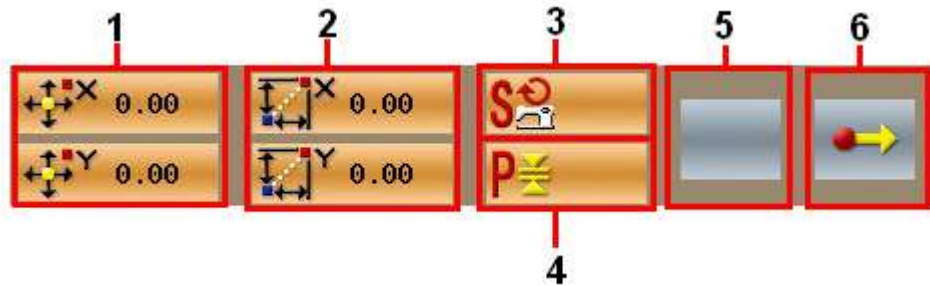

功能说明:

序号	功能	内容
A	读取图案	显示图案读取界面
B	写入图案	显示图案写入界面
C	落针点查询	可以快速查询落针点；在编辑花样时可以直接输入缝制点坐标
D	提针	让机针返回到停车位置
E	中压脚抬升下降	抬升或下降中压脚
F	当前机针位置信息	这是显示现在的机针位置信息的部分
G	编辑功能代码一览表	显示所有可操作的编辑功能，详见【编辑功能一览表】
H	信息显示	显示当前编辑花样的详细信息
I	显示设定	可以进行广角设定以及落针点显示设定等
J	试缝	可以对当前编辑的花样进行试缝
K	前进·后退送布	从现在的针位置移动一针（前进  ；后退  ）
L	原点复位	将现在的机针位置返回到原点。
M	功能按钮	可以直接调用各个按钮上的功能
		 1: 空送
		 2: 点缝
		 3: 普通缝
		 4: 切线
		 5: 消除机械控制命令

序号	功能	内容
		 : 要素删除  : 缝制速度区间修改  : 删除当前编辑的花样图案
N	功能快捷键	通过功能选择·设定(功能代码 112), 可以把需要的功能分配到各按钮, 作为功能快捷键使用。功能被分配后, 表示功能的图标被显示到相应的按键上。
O	花样图案显示区域	显示花样图案。



序号	项目	内容
1	绝对坐标	表示从现在的机针位置的原点的绝对坐标。
2	相对坐标	表示现在的机针位置的相对坐标。
3	速度	表示当前点的缝制速度或空送速度。
4	间隔	表示现在的要素缝制针迹长度。(扩大·缩小读取后, 扩大缩小前的数值被显示。)
5	要素种类	表示当前的要素种类。缝制数据时, 显示该要素种类(空送  、折线  、自由曲线  等)的图标。机械控制命令时, 显示该机械控制命令的种类(切线等)的图标。
6	落针种类	表示有关落针位置的种类。
		 图案起点, 表示是图案的起点位置(原点)。
		 要素中途, 表示是要素内的中途点 (即不是顶点也不是要素终端)

序号	项目	内容
		 顶点，表示是折线的顶点。
		 要素终端，表示是要素的终端位置。
		 图案终端，表示是图案的最终位置。

5.2 花样编辑

使用花样编辑功能，输入如下花样图案。

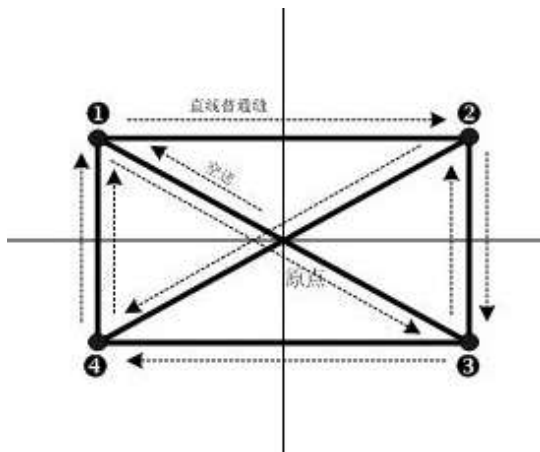

输入点：

	X (mm)	Y (mm)
①	-40.00	25.00
②	40.00	25.00
③	40.00	-25.00
④	-40.00	-25.00

输入次序：如左图中虚线箭头所示。

① 空送的输入

在花样编辑标准界面，按空送按钮





，显示出空送设定界面：



注：也可以从功能代码一览表里直接选择

020：空送，进入该界面。



按确认键后，显示出空送位置指定界面：

在空送位置指定界面，使用方向移动键→A，移动光标（机针位置）到（0，10）

处，按按钮确定后，再按键保存设置，退回到花样编辑标准界面并显示出空送针迹：

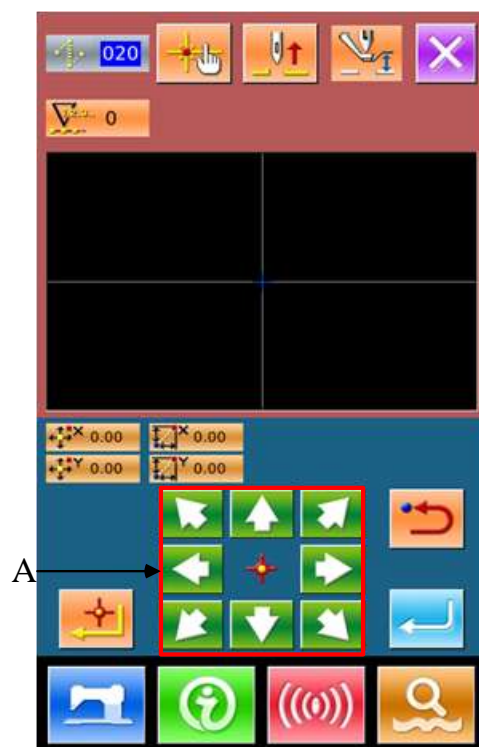

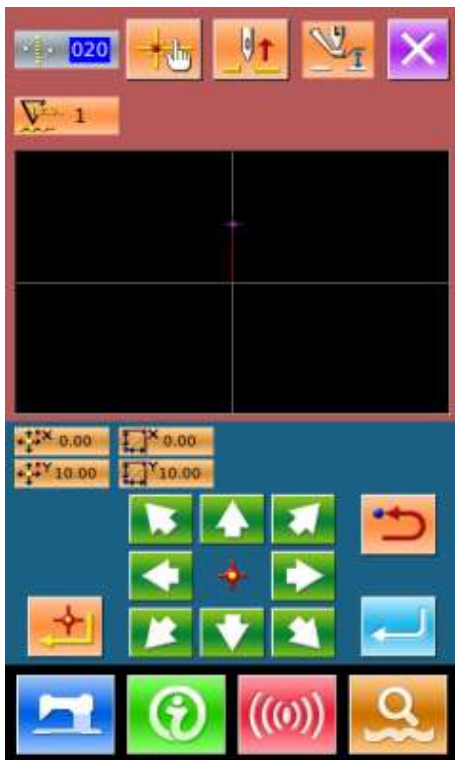

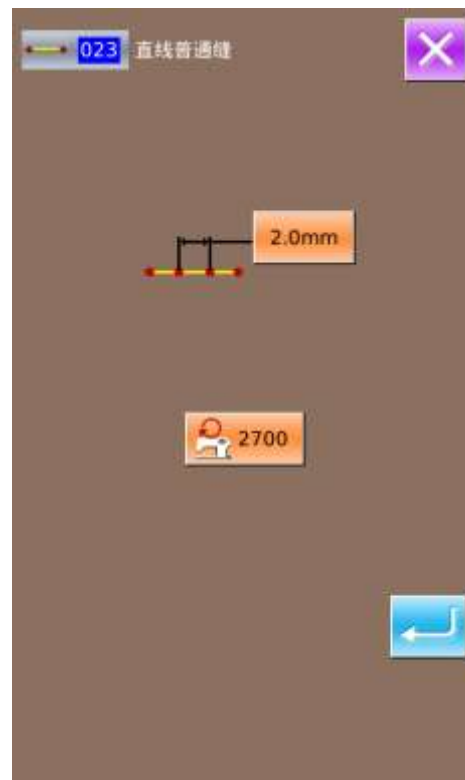

② 直线普通缝的输入

在功能代码一览表里，选择“023 直线普通缝”，然后按确认键后，进入直线普通缝设置界面：



在直线普通缝设置界面下，按缝迹长度设定

按钮 ，进入缝迹长度设定界面，如右图所示。

依次按 、 数字键，将缝迹长度变更为“3.0”，按确认键保存并退回到直线普通缝设置界面。

注：按  键，数值清零。



确认缝迹长度设定按钮的显示值为

“3.0mm”之后，按确认键 ，进入直线普通缝位置设定界面。

在此界面下，通过方向移动键，将光标（机针位置）从①处移动到②处，然后按确定

按钮 。反复进行上述移动操作，将光标按照

② → ③ → ④ → ① → ③ → ② → ④ → ①

的顺序依次移动，如右图所示。

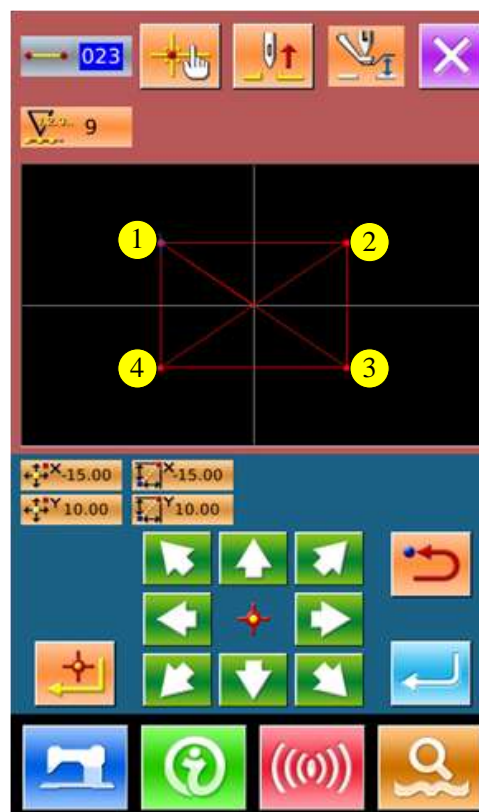



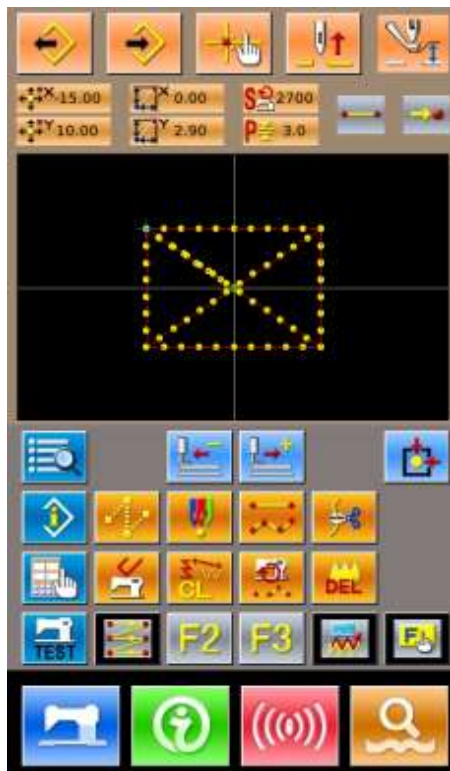



确认花样图案后，按  键生成花样数据并返回到花样编辑标准界面，显示出花样图案。



③ 保存花样

按  按钮，进入图案花样保存界面，保存编辑好的花样图案，如右图所示。

系统自动设定好样号码，用户也可以通过  0 ~  9 十数字键盘或 、 键输入希望值。通过

 和  按键，可以选择花样图案的存储位置。用户

可以选择将其存储在操作面板存储媒介上，也可以选择存储在 U 盘上。



按  键后保存花样图案，系统提示，是否自动插入切线，如右图所示。

按  键自动加入切线；

按  键取消自动加入切线。

操作完成后，退回到花样编辑标准界面。

有关花样编辑的具体操作和说明请参照《SP-510 花样打版使用说明书》。

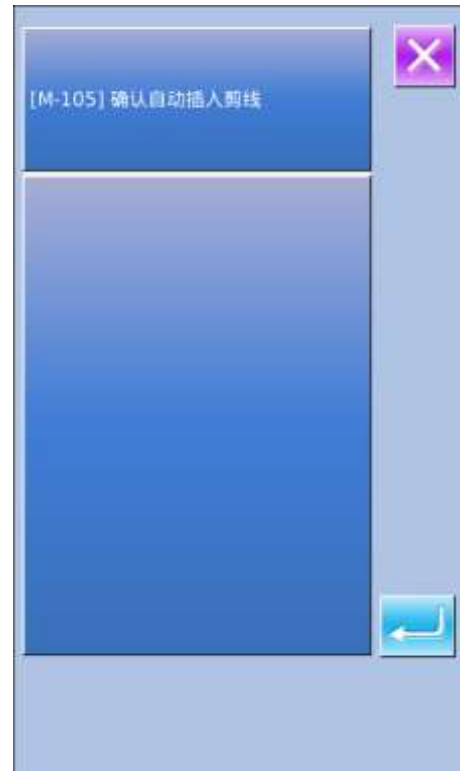

5.3 退出花样编辑模式

在花样编辑标准界面下，按  进入模式选择界面，如右图所示。



按下 ，会与  之间相互切换。其中：

：编辑模式

：缝纫模式

再次按下  键后，退出模式选择界面，系统提示是否返回到缝制模式。

按  键后，退出花样编辑模式，返回到缝纫模式。



6 信息功能

信息功能，有下列3 种功能。

- 1) 可以指定机油更换时期，机针更换时期，清扫时期等，超过了指定事件之后，进行警告通知。
- 2) 利用显示目标值和实际值功能，可以提高生产小组完成目标的意识，可以一目了然地确认进度。
- 3) 显示穿线示意图。

6.1 查看维修保养信息

① 显示信息界面

在数据输入界面，按开关密封部的信息按键（A）之后，信息界面被显示出来。

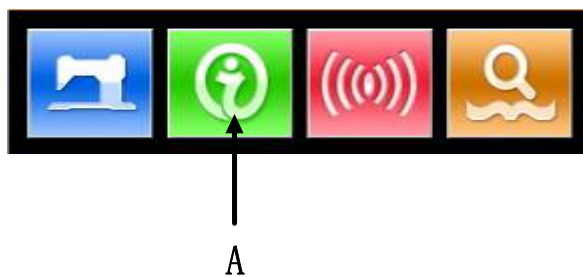

② 显示保养维修界面。

请按信息界面的保养维修信息界面

显示按键  （B）。

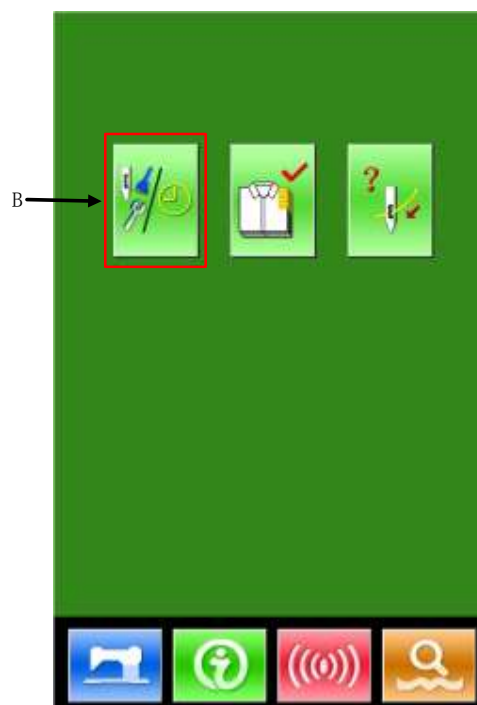

在保养维修信息界面上，有以下3个项目的信息被显示出来。



: 更换机针(千针)



: 清扫时间(小时)



: 机油更换时间(小时)

各项目显示在按键(C)，通知检修的间隔显示在D，至更换的剩余时间显示在E。

点按相应的按键，可以清除至更换的剩余时间。

按退出键直接退回到信息界面。

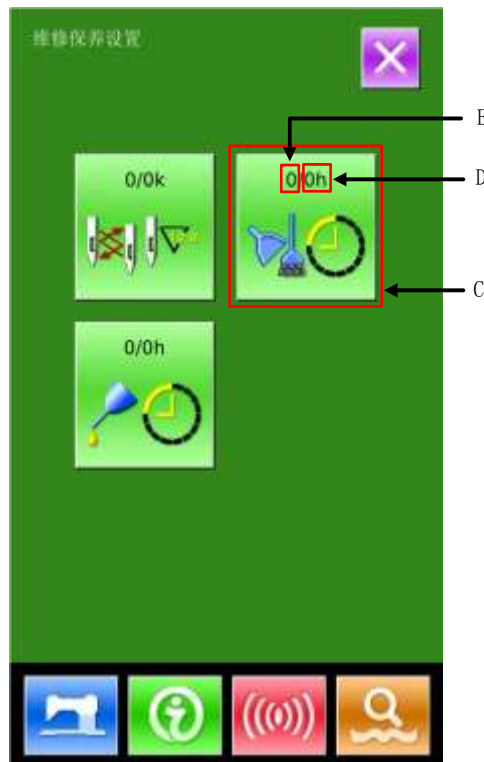

6.2 维修保养时间设置

① 显示信息界面（维修人员等级）

在数据输入界面，按信息按键（A）约3 秒钟之后，信息界面（维修人员等级）被显示出来。

维修人员等级时，有6 个按键被显示出来。

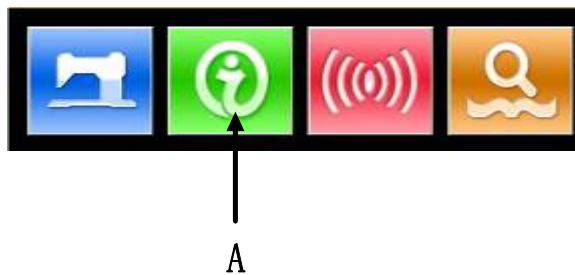

② 信息界面功能

维修人员等级时，有六项功能显示：



：维修保养



：生产管理



：穿线示意



：报警记录



：运转记录



：分期密码

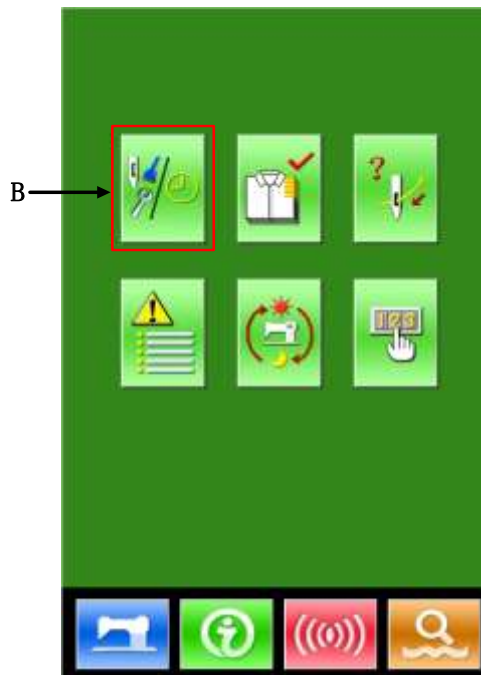

请按信息界面的保养维修信息界面



显示按键 (B)，进入维修保养界面。

③ 维修保养设置

在保养维修信息界面上，显示出与通常的维修保养信息界面一样的信息。按了想变更维修保养时间的项目按键 (C) 之后，相关输入界面被显示出来。



比如按下 键，则可以设置清扫时间。

按退出键  直接退回到信息界

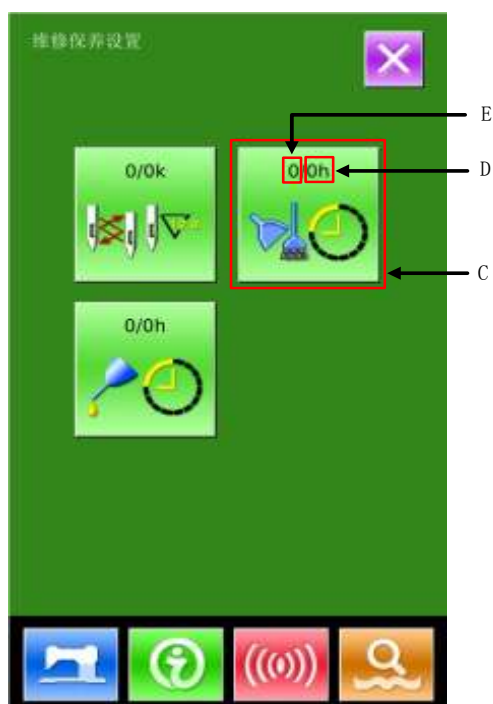

面。

④ 设置维修保养项

把维修保养项设定值设定为0 之后，
则停止维修保养功能。

维修保养设置项包括：

- ◆ 机针更换时间设定
- ◆ 清扫时间设定
- ◆ 机油更换时间设定

按相应的图标，进入设置界面：

A、通过数字键盘输入维修保养项的
设定值。

B、按回车键  之后确定输入。

C、按退出键  直接退回到维修保
养界面。



6.3 警告的解除方法

到了指定的维修保养时间之后，信息提示界面被显示出来。要清除维修保养时间时，请按回车键 。
在清除维修保养时间之前，每次缝制结束后显示信息提示界面。

各项目的信息提示号码如下。

- 机针更换：M-052
- 机油更换时间：M-053
- 清扫时间：M-054

6.4 生产管理信息

在生产管理界面上，指定开始，可以进行从开始到现在的生产件数，生产目标件数的显示等。

生产管理界面的显示方法有以下2 种：

- 从信息界面显示

- 从缝制界面显示

6.4.1 从信息界面显示

① 显示信息界面。

在数据输入界面按了开关部的信息键 (A) 之后, 信息界面被显示出来。

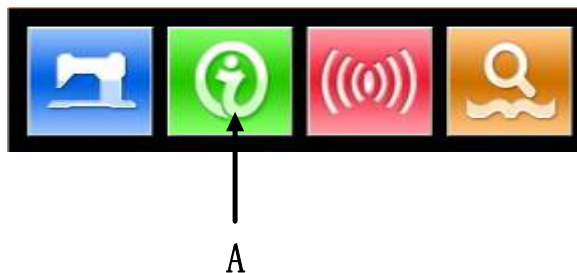

② 显示生产管理界面。

请按信息界面的生产管理界面显示按键 (B)。生产管理界面被显示出来 (如右图所示)。



生产管理界面上显示有下列5个项目的信息。

A：目标值

依照间隔时间自动地显示出截止现在的目标缝制件数。

B：实际值

自动地显示已经缝制的件数。

C：最终目标值

设置最终目标的缝制件数。

D：目标值间隔时间



设置完成一个工序需要的时间(秒)。

E：实际计件间隔

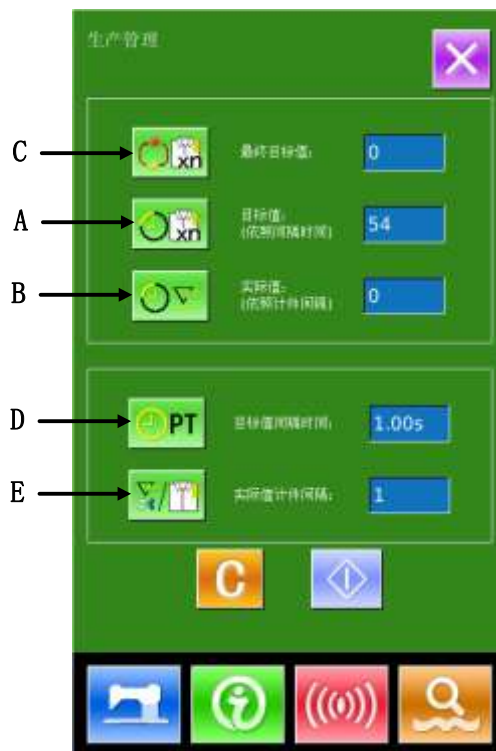
设置实际完成一个工序的间隔



6.4.2 从缝制界面显示

<p>① 显示缝制界面。</p> <p>在数据输入界面按了准备键  之后，缝制界面被显示出来。</p>	
<p>② 显示生产管理界面。</p> <p>在缝制界面，按了信息按键 (A) 之后生产管理界面被显示出来。</p> <p>显示内容和功能与上述6.4.1节相同。</p>	 <p style="text-align: center;">A</p>

6.4.3 生产管理信息设定

① 显示生产管理界面。

按下 ，显示出生产管理界面。



② 输入最终目标值。

首先，请输入从现在开始进行缝制工序的生产目标件数。按了最终目标值

按键  (C) 之后，最终目标值输入界面被显示出来。

请用数字键或加减按键输入希望的

数值。输入后，请按确定按钮 ，



按下退出键  退出。



③ 输入间隔时间。

然后，请输入1 工序需要的间隔时间。按了前页的间隔时间按键



 (D) 之后，间隔时间输入界面被显示出来。

请用数字键或加减按键输入希望的数值。输入后，请按确定按键 ，按下退出键  直接退出。



⑤ 输入计件间隔。

然后，请输入平均1 工序的间隔。按了前页的计件间隔按键  (E) 之后，计件间隔的输入界面被显示出来。

请用数字键或加减按键输入希望的数值。输入后，请按确定按键 ，按下退出键  直接退出。



⑤ 开始车生产件数的计数。

按  键 (I) 之后, 【最终目标值】 【目标值】 【实际值】 变灰, 并开始生产件数的计数。





最终目标值: 可以作为参考时间

目标值: 目标值按照 【目标值间隔】 设定的时长, 开始计时, 每过一个时间间隔增1。

实际值: 当通过 “6.4.2从缝制界面显示” 进入时, 实际值按照 【实际值计件间隔】 设定的值, 开始计件, 每缝完一件增1。

通过设置目标值和实际值可以对比每缝一件的生产效率是提高了还是降低了。

⑥ 停止计数。

计数状态下, 停止键  被显示出来。按了停止按钮  之后, 停止计数。停止后, 在停止按钮的位置显示出计数按钮 。需要继续进行计数时, 请再次按计数按钮 。

在按了清除按钮  之前, 计数的数值不被清除。

按下退出键  直接退出返回。



⑦ 清除计数值。

清除计数的值时，让计数器为停止计

数状态，按下清除按键 。

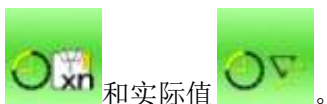

可以被清除的值为现在的目标值



(注：仅在停止计数状态时清除按键可以显示。)

按下清除按键  之后，显示出清除确认界面。

在清除确认界面，按下确定按钮

 确认清除，按下退出键  直接退出。



6.5 显示穿线图

信息界面按下穿线按钮  (C) 之后，上穿线图被显示出来。

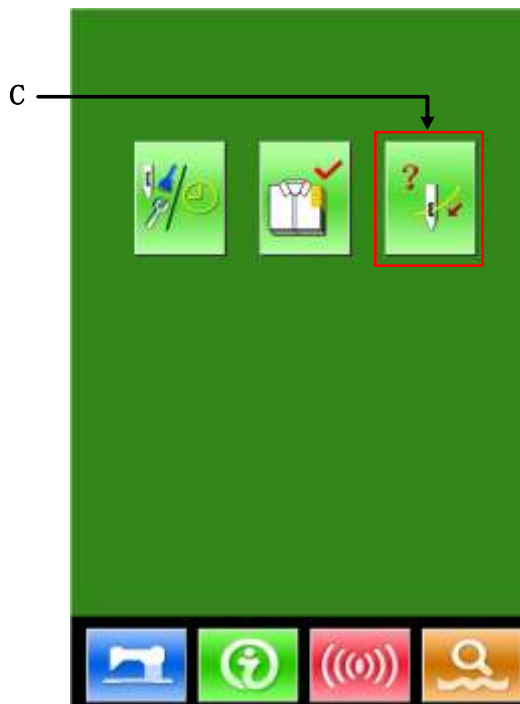

穿线时，请参阅。

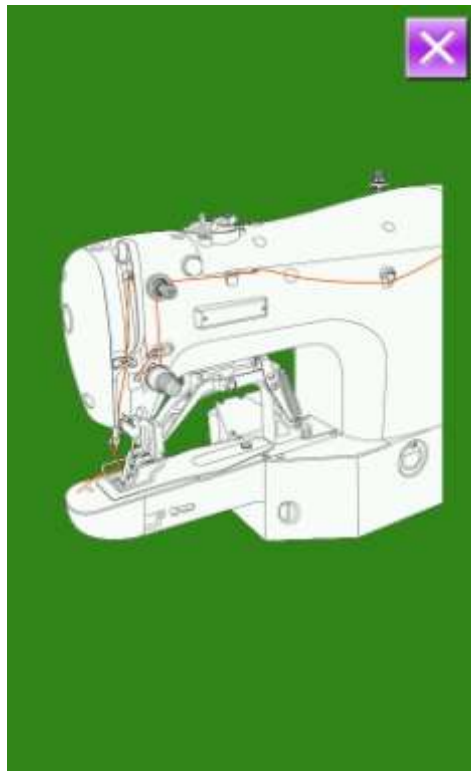

6.6 报警记录





- ① 维修人员等级时，按下  可以查询机器的报警记录信息。



② 按  查询记录

如图，显示报警信息和出现的次数

操作键功能：

- A、按下 、 进行翻页
- B、按下退出键  退出查询操作。
- C、按下清除键  清除保留的报警记录



③ 按报警提示栏左边的序号键, 显示报警记录的详细信息

按  退出。

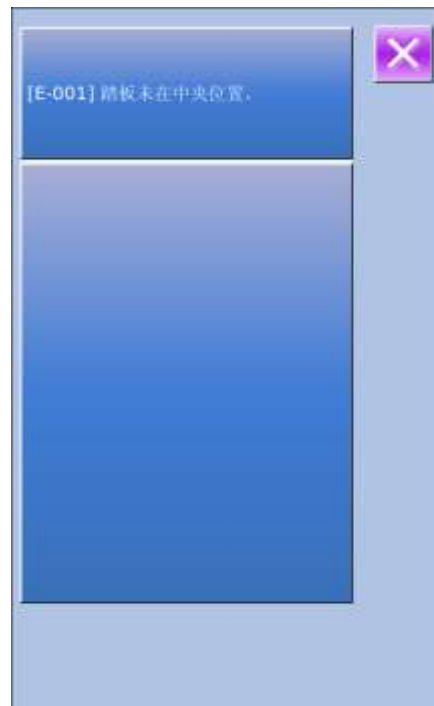

6.7 运转记录

- ① 维修人员等级时，按下  可以查询机器的运转信息。

- ② 运转记录包括：
- ：机器累积运转时间（小时单位）
 - ：机器累积切线次数
 - ：机器累积上电时间（小时单位）
 - ：机器累积针数（1000 针单位）

A、按退出键  退出

B、按清除键清除记录



6.8 分期密码设置

1) 维修人员等级时，按下  可以设置分期密码

该界面下会显示输入用户 ID 界面，输入正确的厂家 ID 后即进入密码管理模式，主要用于用户分期密码的设置和管理。

- ◆ 可以最多设置 10 个不同的密码发
作日期。
- ◆ 系统可以显示厂家设置的密码信
息。



2) 按下  后要求输入厂家 ID

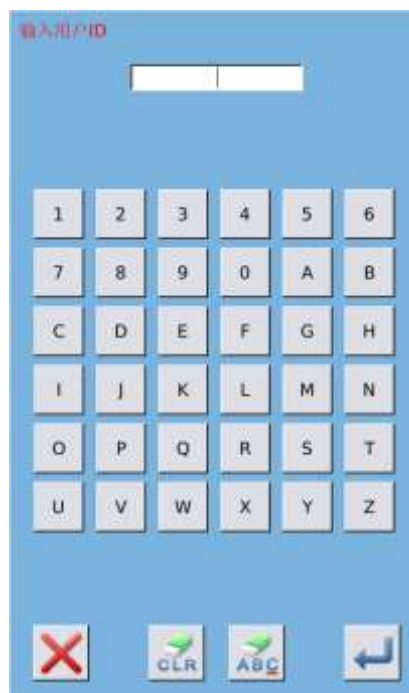

3) 输入正确的厂家 ID 后，进入密码设置界面

分期密码设置步骤：

A、继续输入其他的分期密码



4) 输入板号

按下【板号】键，进入板号输入界面，

输入板号后，按下  完成板号输入界面

※ 板号为四位，范围 0~9999

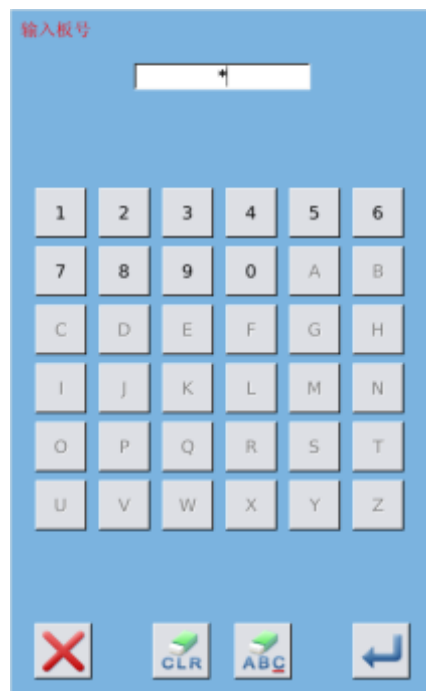

5) 输入系统时钟

按下【时钟】键，进入系统时钟设置界面，确定系统时钟



6) 输入超级密码

按下【超级密码】键，进入超级密码设置界面，输入超级密码

- ※ 最多可输入 9 位总密码
- ※ 密码输入要求确认，两次密码必须一致

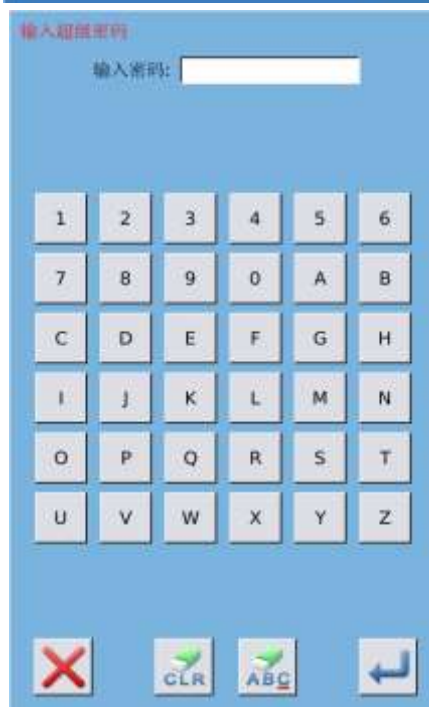

7) 输入分期密码

按下【密码-1】键，进入第一次密码到期界面，要求输入第一个有效日期，

选择合适的日期后，按  确认，然后进入密码设置界面，输入密码

- ※ 日期不能小于系统日期
- ※ 密码输入要求确认，两次密码必须一致



8) 输入其他的分期密码

其他分期密码的设置和⑦相同，参考⑦的设置

※ 下一个有效日期必须大于上一个有效日期



9) 保存密码

A、密码输入完成后，按  完成密码保存

B、密码保存成功，显示【密码保存成功】界面，按  完成密码保存并退回到【信息主界面】

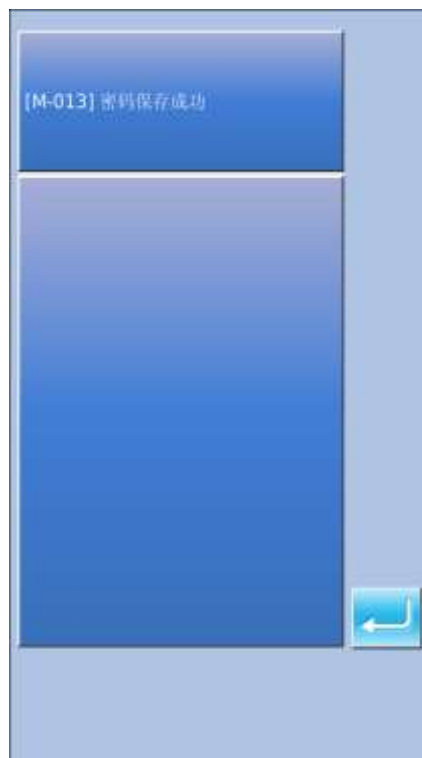

10) 主动清除密码

主动清除密码是指在分期密码发作前主动清除密码的设置

- A、进入密码的方法同密码设置
- B、输入正确的厂家 ID 后，显示右边的界面
- C、系统显示当前时钟和各个分期密码发作日期
- D、按下 ，从前向后依次删除分期密码

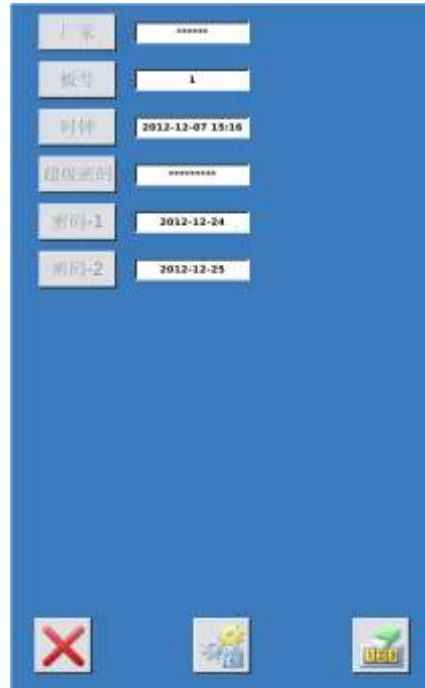

连续输入正确的分期密码后清除当前期的密码，当输入是超级密码时，则全部清除；密码清除后会以红色显示清除的分期日期；如果全部密码清除完毕，则自动退出，返回到信息主界面。

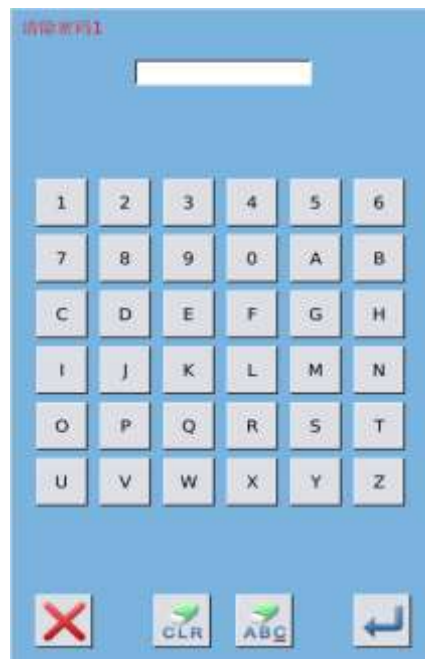

11) 密码发作时清除

如果系统设置了密码，并且没有清除，则使用至密码发作日期时，会遇到密码发作。

此时若继续使用，必须输入密码才能继续正常使用。

A、有效密码包括当期提示的密码和超级密码。

B、若输入的是当期密码，则清除当期密码。清除当前密码后，若后面没有密码，则机器不再会出现密码发作的问题。

C、若输入的是超级密码，则全部清除分期密码。

7 通讯功能

通信功能完成以下几项功能：

- 把其它缝纫机编制的缝制数据或打版软件编制后的缝制数据下载到缝纫机；
- 向U盘或计算机里加载缝制数据。
- 从U盘加载参数
- 将操作头中保存的参数导入到U盘中
- 操作头软件升级

7.1 关于可以处理的数据

可以处理的缝制数据如下：

数据类型	标准格式
VDT	[0-9][0-9][1-9].vdt
DXF	[0-9][0-9][1-9].dxf
DST/DSB	[0-9][0-9][1-9].dst/ [0-9][0-9][1-9].dsb
B/BA	[0-9][0-9][1-9].(1-599)/ [0-9][0-9][1-9].(600-999)
PAT	[0-9][0-9][1-9].pat

往U盘保存数据时，请保存到DH_PAT文件夹里，否则就不能读取文件。

7.2 功能操作

① 显示通信界面

在数据输入界面，按通信键之后，
显示出通信界面。

② 选择相应操作

该界面下可选择的功能，分为三类：

- 花样传输
- 参数传输
- 软件升级

点按相应的图标，进行功能操作。

③ 按通讯键退出通讯功能



7.3 花样传输

① 显示通信界面

在通讯界面下，按：

A：从U盘中向操作头导入花样

B：将操作头中保存的花样导出到U盘
中

U盘的路径：DH_PAT

- ※ 从U盘导入花样时，请将花样文件保存在U盘的DH_PAT目录中
- ※ 从操作头导出花样时，导出的花样文件保存在U盘的DH_PAT中

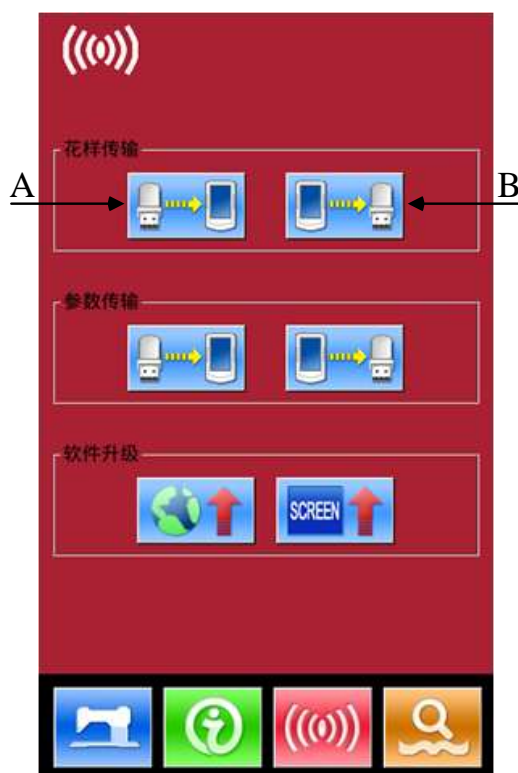

※ U盘中的花样命名方式

从U盘导入花样时，请遵守下面的规则

命名：

文件名：三位数字，001~999

后缀名：vdt（大小写无关）

举例：

正确的文件命名： 100.vdt、102.VDT

其他的命名方式不正确，系统不能识别。

② 按A指示键，进入从U盘向操作头导入花样界面

注：如果U盘中花样与操作头中花样存在同名的情况，花样号码会显示出红色，此时红色号码的花样就需要利用F键操作才能导入操作头。如图1所示。

A、利用【上箭头】、【下箭头】键进行翻页

B、利用下面三种操作，选择花样

- 按  选择全部花样，
- 按  反向选择
- 点击花样号码按键

C、按  完成导入花样功能，此时导入操作头的花样号与选择的花样号保





图 1

持一致。如图 2 所示。

D、按  完成选中花样的删除功能

E、按退出键  退出到通讯界面。

F、当选中某个花样后，按  键，出现图3所示界面，输入要存入的花样号；

G、如果选中好几个花样，则不能进行上一步操作。按退出键  退出到上一界面。



图 2

注意：如果选择花样号在操作头中已存在，会出现如图4所示。如果是其他格式的数据，操作头会自动将其转换成vdt格式数据，存入内存。



图 3

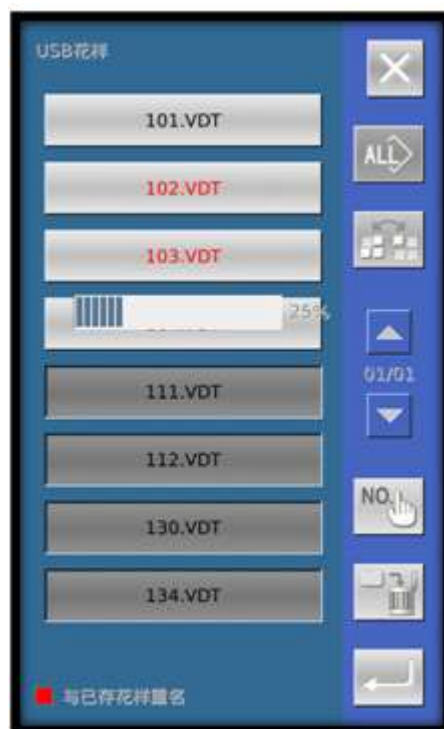

图 4

③ 按B指示键,完成操作头的花样导出到U盘中

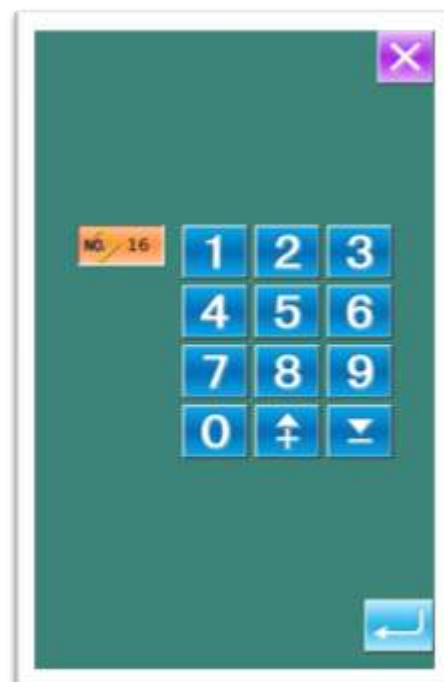
A、利用【上箭头】、【下箭头】键进行翻页

B、利用下面三种操作,选择花样

- 按  选择全部花样,
- 按  反向选择
- 点击花样号码按键

C、按  完成选中花样的删除功能

D、按  完成导出花样功能

E、按退出键  退出花样导出功能界面



F、在该界面下，按  键，显示当前内存中花样占用的空间，及花样的个数

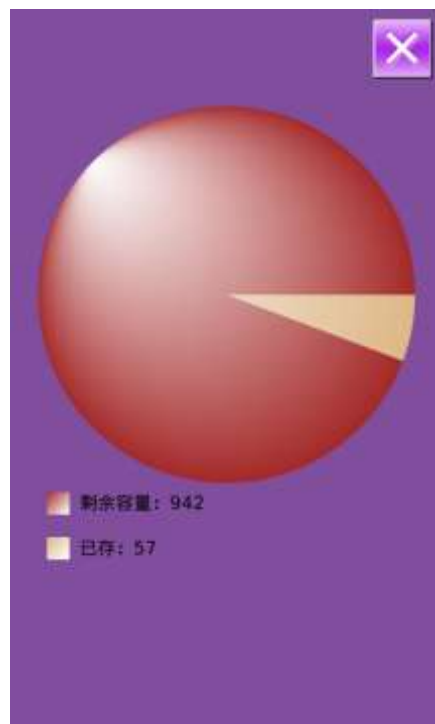

7.4 参数传输

① 显示通信界面

在通讯界面下，按：

A：从U盘中向操作头导入参数

B：将操作头中保存的参数导出到U盘中

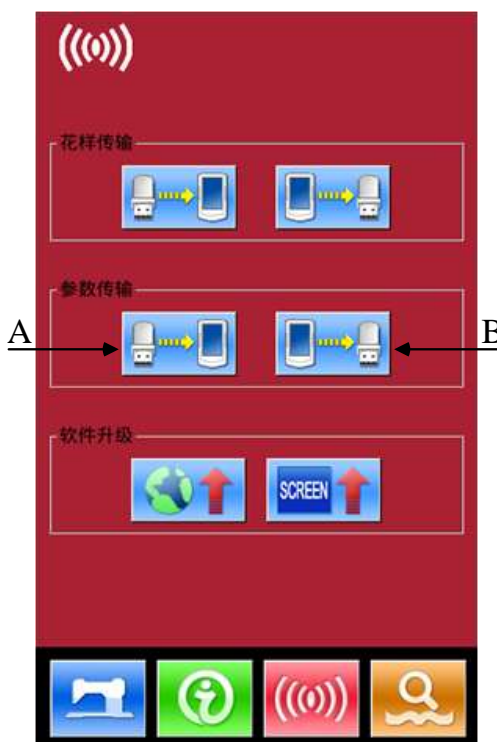

※ 从U盘导入参数时，请将参数文件保存在U盘的DH_PARA目录中，并命名为：ukParam

※ 从操作头导出参数时，导出的参数文件保存在U盘的DH_PARA中，参数文件：ukParam

※ 参数文件是二进制文件，对文件的操作在操作头上完成，不要手动修改文

件，以免影响使用。

② 按A指示键，完成从U盘向操作头导入参数

A、按回车键  完成从 U 盘向操作头导入参数并退出

B、按退出键  直接退出



③ 按B指示键，完成操作头的参数导出到U盘中

A、按回车键  完成从操作头向 U 盘导出参数并退出

B、按退出键  直接退出



7.5 软件升级

1) 显示通信界面

在通讯界面下，按A键进入软件升级界面。

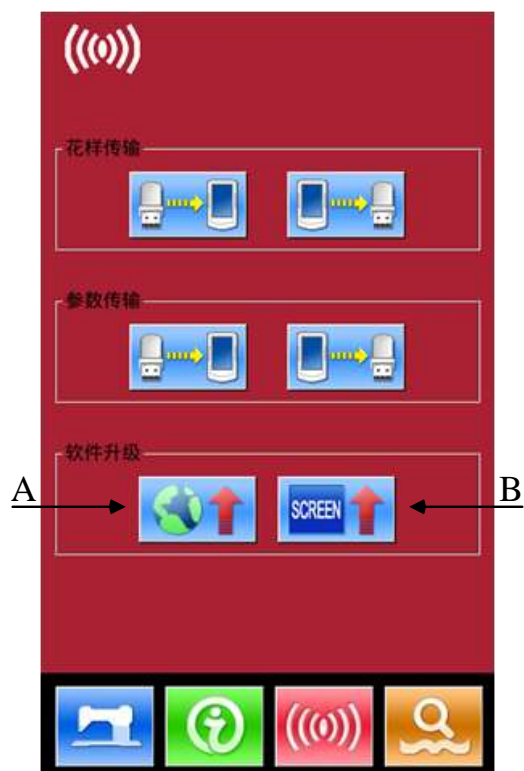

2) 升级类型选择

软件升级包括：

- ◆ 操作头程序
- ◆ 图标
- ◆ 显示字库
- ◆ 开机画面

按 ◀ 和 ▶ 键进行翻页

A、按回车键  完成选中功能的升级，并退出

B、按退出键  直接退出

C、各个功能键能同时多选，系统顺序执行相应的升级功能

D、升级完成后，关机重启即可



3) 按B进入开机画面升级界面

将开机画面生成的bin文件放入U盘的
update目录下，选择bin文件后，按回

车键  完成开机画面的升级。



8 模式和参数设置

按下  可以切换数据输入界面和模式界面（如右图所示），在该界面下可以进行一些详细的设置和编辑操作。

长按  键 3 秒可以进入设置模式等级 2 状态，常按 6 秒可以进入设置模式等级 3 状态。



设置模式等级 2



设置模式等级 3

8.1 功能说明

序号	图标	功能	内容
1		一级参数设置	进行一级（U）参数设置。
2		计数器设置	可以设置计数器类型、计数值和设定值。
3		缝制类型设置	切换普通花样缝纫和组合花样缝纫。
4		花样锁定	可以进入花样锁定设置界面。
5		花样编辑	可以进入花样编辑。
6		格式化 U 盘	格式化 U 盘。
7		软件版本查询	查询当前面板、主控、电机软件版本。
8		键盘锁定	可以锁定一些可设定项功能。
9		检测模式	针对机器外设和液晶进行检测。
10		参数备份	可以对当前参数进行备份和恢复。
11		编辑参数开关	可以对编辑下参数进行打开或关闭操作。
12		二级参数设置	进行二级（K）参数设置。
13		视频播放	可播放视频文件

8.2 一级参数设置

① 参数设置操作



选择  进入一级参数设置界面（如右图所示）。



按  键退出参数设置界面。

当有参数修改时，在参数设置界面显示【已修改】按键，

选择想要修改的参数后进入设置状态，参数设置分为数据输入类型和选择类型。举例如下：

选择 U01，进入界面

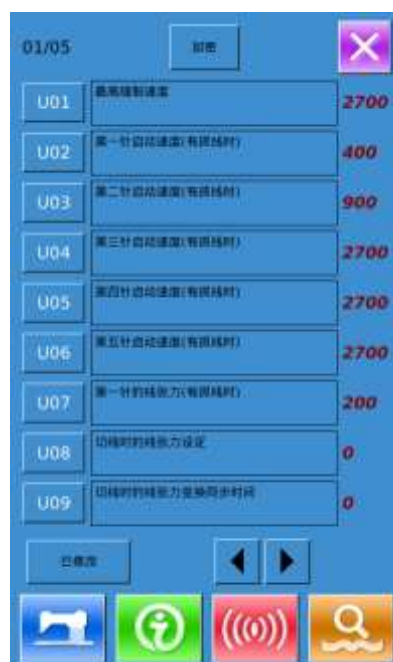

选择 U25，进入界面



② 参数加密

A、按“加密”键后，进入密码输入界面。

按  全部清除输入内容

按  每按一次删除一个字符

B、输入正确的密码后，进入参数加密界面

选择要加密的参数

按【全选】，全部参数加密

按【反选】，反向选择参数加密

按【改密】，修改加密密码，默认是厂

家 ID

按退出键  退出加密功能

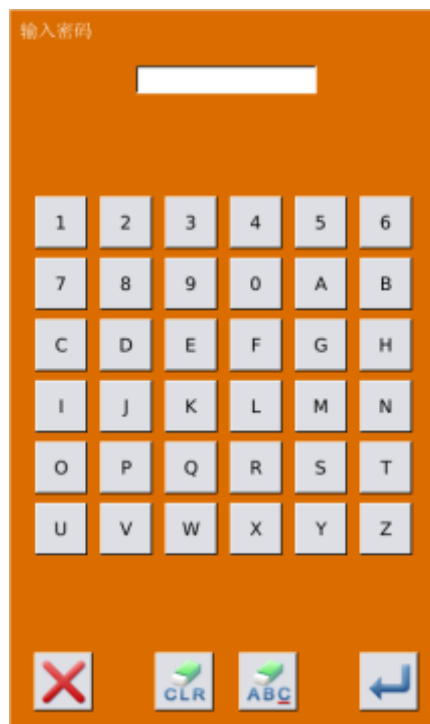

③ 查询已修改参数

A、当有参数修改时，在参数设置界面显示【已修改】按键

B、在参数设置界面，按下【已修改】按键，可以查询已修改过的参数。

首先要求输入密码，输入密码界面的操作参考②的 A 项，输入正确的密码后进入到已修改参数查询界面

C、在已修改参数查询界面下，可以查询到所有修改过的参数列表，在该列表中显示修改的当前值和复位值。

在该界面下：

- 按【还原所有】按键，将修改的参数恢复为复位值
- 点按参数名称键，例如【压脚类型】，再点按【选择还原】将选中的参数恢复为复位值。参数键可以多选。
- 按参数号码键，例如【U14】，能够进入参数设置界面，可以重新设置参数数值。
- 存在多于 1 个页面时，通过箭头按键可以翻页操作。
- 点按 ，退出该界面

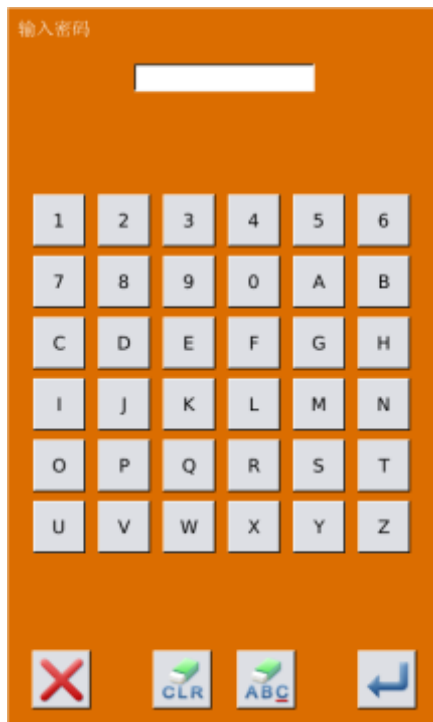

④ 一级参数表

序号	参数	设定范围	编辑单位	出厂设置
U01	最高缝制速度	400~2500	100rpm	2700rpm
U02	第一针启动速度（有抓线时）	400~1500	100rpm	1500rpm
U03	第二针启动速度（有抓线时）	400~3000	100rpm	3000rpm
U04	第三针启动速度（有抓线时）	400~2500	100rpm	3000rpm
U05	第四针启动速度（有抓线时）	400~2500	100rpm	3000rpm
U06	第五针启动速度（有抓线时）	400~2500	100rpm	3000rpm
U07	第一针的线张力（有抓线时）	0~200	1	200
U08	切线时的线张力设定	0~200	1	0
U09	切线时的线张力变换同步时间	-6~4	1	0
U10	第一针的启动速度	400~1500rpm	100rpm	400rpm
U11	第二针的启动速度	400~2500rpm	100rpm	900rpm
U12	第三针的启动速度	400~2500rpm	100rpm	2700rpm
U13	第四针的启动速度	400~2500rpm	100rpm	2700rpm
U14	第五针的启动速度	400~2500rpm	100rpm	2700rpm
U15	第一针的线张力（无抓线时）	0~200	1	0
U16	启缝时的线张力切换相位	-5~2	1	-5
U25	压脚分段开关 ON: 压脚分段 OFF: 禁止压脚分段	0: 压脚分段 1: 禁止压脚分段	1	1
U26	2级行程时压脚分段高度调整	50~90	1	70
U27	缝制计数器计数单位	1~30	1	1
U31	操作头按键可以停止缝纫机操作 OFF: 无效 PANEL: 操作盘暂停按键 EXT: 外部暂停键	0: 无效 1: 操作盘暂停按键 2: 外部暂停	1	1
U32	蜂鸣器声音设定 OFF: 禁止蜂鸣器 PAN: 操作盘声音 ALL: 操作盘加报警	0: 无蜂鸣音 1: 操作盘音 2: 操作盘+报警音		2
U33	抓线的放针数	1~7	1	2
U34	抓线的演示时相	-10~0	1	-5
U35	抓线开关禁止 ON: 允许 OFF: 禁止	0: 允许 1: 禁止动作	1	1
U36	选择送布动作时间	-8~16	1	12

序号	参数	设定范围	编辑单位	出厂设置
U37	缝完后先回起缝点还是先抬压脚	0: 先回起缝点再抬压脚	1	1
	脚 0: 先回起缝点再抬压脚 1: 先抬压脚再回起缝点 2:先踩踏板再抬压脚	1: 先抬压脚再回起缝点		
U38	自动加工完成后压板抬起 ON: 压脚上升 OFF: 禁止压脚上升	0: 压脚上升 1: 禁止压脚上升	1	0
U39	缝制结束后是否检索原点（不包含组合缝） OFF: 无原点检索 ON: 有原点检索	0: 无原点检索 1: 有原点检索	1	0
U40	设定组合缝制时的原点检索 OFF: 无原点检索 PAT: 每一图案结束后 CLC: 每一循环结束后	0: 无原点检索 1: 每一图案结束后 2: 每一循环结束后	1	0
U41	设定 P 花样切换时的原点检索 OFF: 无效 ON: 有效	0: 无效 1: 有效		0
U42	针杆停止位置 UP: 上位置 DEAD: 上死点	0: 上位置 1: 上死点	1	0
U46	设定禁止切线 ON: 允许切线 OFF: 禁止切线	0: 允许 1: 禁止	1	0
U49	绕线速度设置	800~2000	100rpm	1600rpm
U64	选择尺寸变更单位 %: 输入百分比 SIZ: 输入实际尺寸	0: 输入百分比 1: 输入实际尺寸		0
U88	缩放模式 OFF: 禁止 PIT: 间隔增减 STI: 针数增减	0: 禁止 1: 间隔增减 2: 针数增减		1
U97	暂停后的切线方式 AUT: 自动切线 MAN: 手动切线	0: 自动切线 1: 手动切线	1	0
U135	缝制结束后回起缝点还是回原点	0: 缝制结束后回起缝点	1	0

序号	参数	设定范围	编辑单位	出厂设置
	0: 缝制结束后回起缝点 1: 缝制结束后回原点	1: 缝制结束后回原点		
U190	背光自动关闭 OFF: 不能自动关闭 ON: 自动关闭	OFF: 否 ON: 是		0
U191	背光自动关闭等待时间	1~9	1m	3m
U192	液晶背光亮度调节	20~100		100
U193	禁止计数器被修改 OFF: 允许修改 ON: 禁止修改	0: 允许修改 1: 禁止修改		0
U194	计数器达到设定值时缝纫机的操作 OFF: 停止缝纫 ON: 可继续缝纫	OFF: 停止缝纫 ON: 可继续缝纫		0
U195	音量大小	30~63		50
U200	语言选择 0: 中文 1: 英文 RU:pyccKNN	0: 中文 1: 英文		0
U201	开机是否进入语言设置 OFF: 不能进入 ON: 开机就进入	OFF: 否 ON: 是		0
U212	气阀分离压脚下降顺序 0: 同时下降 1: 先下降左再下降右 2: 先下降右再下降左	0: 同时下降 1: 先下降左再下降右 2: 先下降右再下降左		0
U213	气阀分离上升顺序 0: 同时上升 1: 先上升左再上升右 2: 先上升右再上升左	0: 同时上升 1: 先上升左再上升右 2: 先上升右再上升左		0
U214	翻转压脚使能 OFF: 禁止 ON: 使能	0: 禁止 1: 使能		1

8.3 二级参数设置

① 参数设置操作

在设置模式等级 3 下，选择  进入二级参数设置界面（如右图所示）。操作方法参照“8.2 一级参数设置”。
 当有参数修改时，在参数设置界面显示【已修改】按键，

按  键退出参数设置界面



② 参数加密

参数加密的操作步骤，请参考“8.2 一级参数设置”

按  键退出参数加密界面

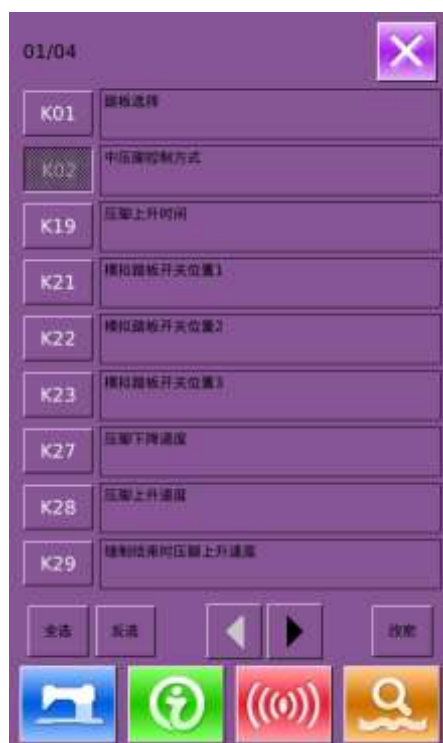

③ 已修改参数查询

当有参数修改时，在参数设置界面显示【已修改】按键，

点按【已修改】按键可以查询已修改过的参数，并且可以进行参数的复位。

具体操作可参考“8.2 一级参数设置”

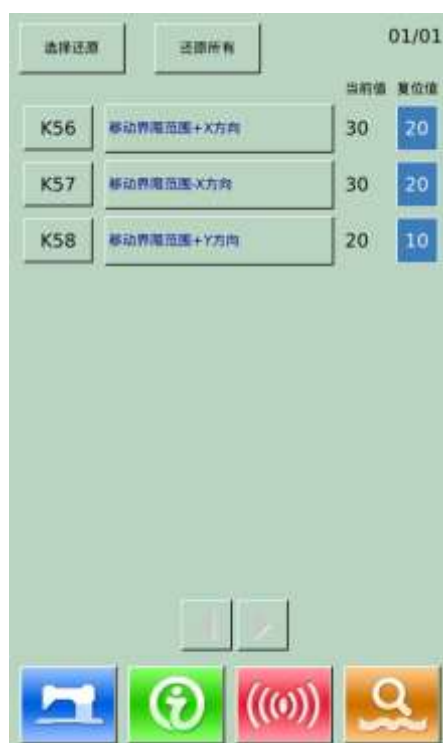

④ 二级参数表

序号	参数	设定范围	编辑单位	出厂设置
K01	踏板选择 0: 模拟踏板 2: 双踏板 3: 双踏板，但只运行踏板起控制作用	0: 模拟 2: 双踏板 3: 双踏板，但只运行踏板起控制作用	1	0
K02	中压脚控制方式 0: 无中压脚控制 2: 电磁铁控制中压脚 3: 机械控制中压脚	0: 无中压脚控制 2: 电磁铁控制中压脚 3: 机械控制中压脚		0
K19	压脚上升时间	0~50（仅气阀适用）	5	30
K21	模拟踏板开关位置 1	50~200	1	70
K22	模拟踏板开关位置 2	50~200	1	120
K23	模拟踏板开关位置 3	50~200	1	185
K27	压脚下降速度	100~4000pps	10pps	4000pps
K28	压脚上升速度	100~4000pps	10pps	1500pps
K29	缝制结束时压脚上升速度	100~4000pps	10pps	3000pps
K43	切线速度	400: 切线速度 400 800: 切线速度 800	400rpm	400rpm
K44	切线空送布控制有无 OFF: 无效	OFF: 无效 ON: 有效	1	1

	ON: 有效			
K45	切线空送布控制时针孔导向直径	1.6~4.0mm	0.2mm	1.6mm
K56	移动界限+X 方向	0~50mm	1mm	20mm
K57	移动界限-X 方向	0~50mm	1mm	20mm
K58	移动界限+Y 方向	0~30mm	1mm	10mm
K59	移动界限-Y 方向	0~30mm	1mm	20mm
K64	拨线方式选择 0: 电磁铁拨线 1: 电机拨线	0: 电磁铁拨线 1: 电机拨线	1	1
K66	压脚联动拨线操作脉冲数	30~60	1	45
K74	电磁/气动压脚选择 AIR: 气动压脚 MOTO: 电机压脚	0: 气动压脚 1: 电机压脚	1	1
K95	切线角度	-10~10	1	0
K112	停车位置补偿	-10~10	1	0
K122	OC	-128~128	2	0
K123	OD	-128~128	2	0
K124	BD	-512~512	4	0
K125	OC	184.5~244.5	0.1	208
K126	OD	144.6~204.6	0.1	174
K127	BD	39~59	0.1	53
K128	步进控制方式	0: DSP1 闭环 DSP2 闭环 1: DSP1 开环 DSP2 闭环 2: DSP1 闭环 DSP2 开环 3: DSP1 开环 DSP2 开环	0~3	1
K135	电磁铁分线延时	-10~30	1	0
K137	电磁铁抓线角度偏移	-150~150	1	0
K138	电磁铁吸合延时	-1~1	1	0
K140	线张力控制方式 0: 电子夹线 1: 机械夹线	0: 电子夹线 1: 机械夹线	1	0
K141	支线张力电磁铁吸合力度微调	-20~20	1	0
K142	支线张力电磁铁保持力度微调	-40~40	1	0
K144	电机分线延时 (仅方正可见)	-15~15	1	0
K145	电机剪线延时 (仅方正可见)	-10~10	1	0
K150	机头安全开关输入的禁止选择 ON: 通常 OFF: 禁止	0: 通常 1: 禁止		0

K200	恢复出厂参数			
K241	机型设置 注：更改机型时会重新加载基础花样，并删除掉已保存的普通花样	0：加固机 5：1906 机型 7：钉扣机		0

8.4 计数器设置



按下  进入计数器设置界面（如右图所示）。

操作步骤：

① 缝制计数器类型选择

选择缝制计数、件件计数功能

② 设定当前值、设定值

在选定的类型中按“当前值”、“设定值”
按键，进行有关操作

③ 选择加计数还是减计数

在选定的类型中，按“加”、“减”按键，
进行有关操作。



按  键退出计数器设置界面。



按  完成设置，并退出。

缝制加计数：

每缝制 1 形状的缝制物之后，在当前值上加数。当当前值与设定值相等时，显示出计数器溢出报警界面。按下  键，计数器当前值恢复为 0。

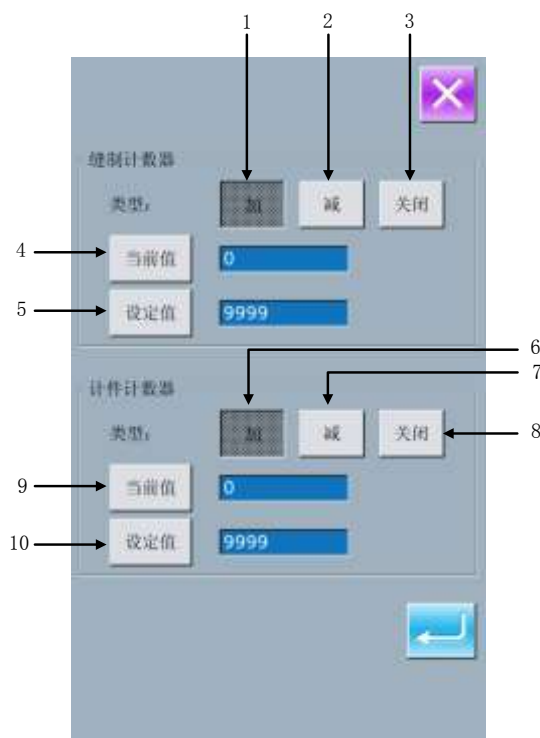

缝制减计数:

每缝制 1 形状的缝制物之后, 从当前值减 1。当当前值等于 0 之后, 显示出计数器溢出报警界面。按下  键, 计数器当前值恢复为设定值。

计件加计数:

每缝制 1 循环或 1 连续缝, 在当前值上进行加数。当当前值与设定值相等时, 显示出计数器溢出报警界面。按下  键, 计数器当前值恢复为 0。

计件减计数:

每缝制 1 循环或 1 连续缝, 从当前值减 1。当当前值等于 0 之后, 显示出计数器溢出报警界面。按下  键, 计数器当前值恢复为设定值。

④ 关闭计数器

在选定的类型中, 按“关闭”按键, 关闭计数器。

8.4.1 功能介绍

序号	功能
----	----

1	缝制计数器加计数
2	缝制计数器减计数
3	关闭缝制计数器
4	设定缝制计数器当前值
5	设定缝制计数器设定值
6	计件计数器加计数
7	计件计数器减计数
8	关闭计件计数器
9	设定计件计数器当前值
10	设定计件计数器设定值

8.5 变换缝制类型

按下  进入缝制类型选择界面。

 : 普通缝

 : 循环缝



确定缝制类型之后, 按下  结束。按

 之后, 显示出选择的缝制类型的数据输入界面。

按  键退出变换缝制类型界面, 原来的缝制类型不变。



8.6 进入花样编辑

按下 ，如下两种图标会互相切换，选择对应的模式，再按  即可进入花样编辑模式。（参照 5.1 节描述）

：缝纫模式

：编辑模式



8.7 花样锁定设置

在设置模式等级 1 下，按下  进入花样锁定设置界面，该界面会显示所有花样号，每页显示 32 个。如果要锁定某花样，按与花样号对应的按键即可，选中花样号凹下显示。

按下 ，将会保存设置，所有选中的花样将全部锁定。



8.8 格式化操作

按下  进入锁键盘设置界面。

在该界面下，可以完成：

- U 盘格式化
- 内存花样格式化
- 自定义格式化
- P、C 花样格式化

按下相应的功能键，进入相关界面。

按退出键  退出格式化 U 盘



② 按“USB”键，进入 U 盘格式化

按回车键  全部格式化 U 盘文件

按退出键  退出格式化 U 盘



③ 按“内存”按键，格式化内存花样

格式花样包括：

- 普通花样，包括基础花样和用户花样
- 循环缝 C 花样
- 登记的 P 花样

按回车键  全部格式化

按退出键  退出格式化



※ 格式化内存花样会将内存中存在的全部花样文件删除，请谨慎操作！

④ 按“自定义”键，进入批量删除功能

在该界面下，会显示当前内存中存在的所有花样文件，点按相应的按键完成批量删除功能。

自定义功能的操作：

A. 利用“上箭头”、“下箭头”键进行翻页

B. 利用下面三种操作，选择花样

- 按  选择全部花样，
- 按  反向选择
- 点击花样号码按键

C. 按  完成批量删除功能

D. 按退出键  退出到格式化操作界面。



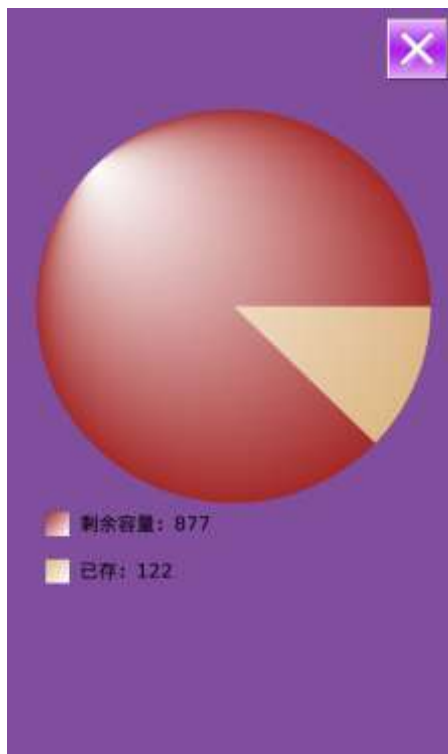

- ⑤ 在自定义格式化界面下，按  键，显示当前内存中花样占用的空间，及剩余空间的大小

按退出键  退出到上一界面。



8.9 软件版本查询

在设置模式等级 2 下，按下  可以查询系统软件版本

 :可以将当前版本信息保存至 U 盘根目录下。

A software version query screen with a close button (X) in the top right corner. It lists various components and their versions in a list format. At the bottom right, there is a save icon (floppy disk with gears).

面板版本:	SC203-KD-A-v1.0.88
主控版本:	SC202-MC-A-v1.0.138
主轴电机版本:	SC202-MM-A-v1.0.138
步进电机1版本:	SC202-MD-A-v1.0.22
步进电机2版本:	SC202-MD-A-v1.0.22
文件系统版本:	SC203-FS-A-v1.0.19
操作系统版本:	SC203-OS-A-v1.0.8
编译时间:	2013-06-9

8.10 检测模式

在设置模式等级 2 下,按下  键可以进入检测模式界面(如右图所示)。



各图标功能说明详见下表:

序号	名称
A	I01 触摸屏校正
B	I02 液晶显示检测
C	I03 输入检测
D	I04 转速测定
E	I05 输出检测
F	I06 连续运转
G	I07XY 马达原点检测
H	I09 压脚马达/原点传感器检测
I	抓线马达/原点传感器检测

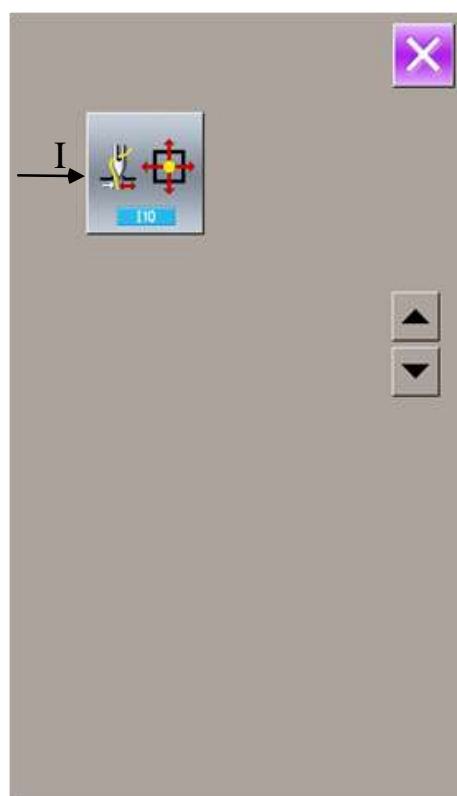
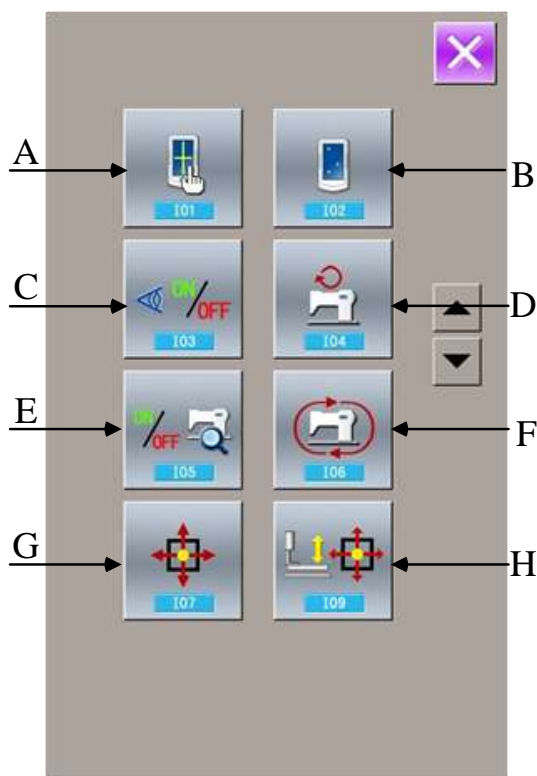
按  键退出检测模式界面。



(1) 触摸屏校正

A、在检测模式界面按下  (I01 触摸屏校正) 键，提示【确定进入触摸屏校正模式】，按  进入触摸屏校正界面（如右图所示），按  可以退出触摸屏校正状态。

B、需要进行 5 点校正，最好采用触摸笔一类的工具点击画面中的十字光标，校正结束后，会显示本次操作是否成功

※ 校正过程中，请务必按照十字光标标识的位置进行，否则会导致校正结束后无法正常使用触摸屏的情况

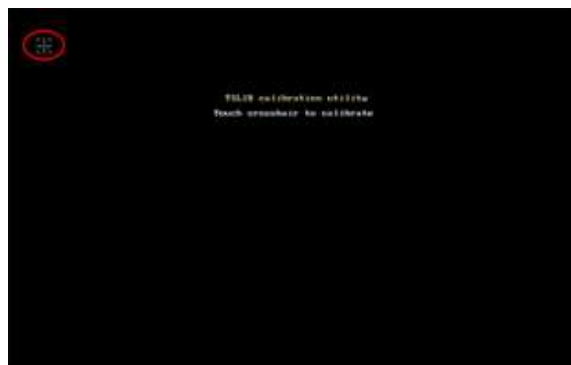

(2) 液晶检测

在检测模式界面按下  (I02 液晶检测) 键进入液晶检测界面（如右图所示），在该状态下检测液晶是否失色。

在界面下点按，在“蓝色 — 黑色 — 红色 — 绿色 — 白色”间循环显示

按退出键  退出液晶检测界面。



(3) 输入信号检测方法

在检测模式界面按下  (I03 输入检测) 键进入输入检测界面 (如右图所示), 在该界面下可以确认各种开关和传感器的输入状况。

ON: 表示开启

OFF: 表示关闭

01: 启动开关

02: 压脚开关

03: 模拟踏板

04: X 马达传感器

05: Y 马达传感器

06: 外压脚马达原点传感器

07: 机头翻转传感器

08: 切线马达传感器



(4) 转速测定

① 显示转速测定界面

在检测模式界面按下  (I07 转速测定) 键进入转速测定界面 (如右图所示), 在该界面下可以检测主轴马达转速。

按  退出转速测定界面。

② 转速测定设置

通过按加键“+”和按减键“-”可以设置主轴马达转速, 按下  后, 主轴马达会以已设定的转速旋转。此时, 实际测得的转速在界面中的实际转速

栏中显示。按下  则机器停止运转。



(5) 输出检测

在检测模式界面按下  (I05 输出检测) 键进入输出检测界面(如右图所示), 在该界面下可以检测的输出状态包括:

01: 松线电磁铁检测

02: 面线电磁铁检测

按  退出输出检测界面



※ 注意缝纫机会有相应的动作

(6) 连续运转

① 显示连续运转界面

在检测模式界面按下  (I06 连续运转) 键进入连续运转界面(如右图所示)。

A: 动作间隔

B: 收针原点检测

按  退出连续运转界面。





② 连续运转设置

点击连续运转状态下的“动作间隔”输入框和“收针原点检测”输入框, 通过数字键盘输入设置值, 可设定动作间隔时间和收针原点检测。



按  键，踩下脚踏板即开始连续运转。连续运转过程中可以通过暂停开关暂停，也可以在动作结束后压脚抬起时踩下脚踏板或按暂停开关停止连续运转。



(7) XY 马达原点传感器检测

在检测模式界面按下  (I07XY 马达原点检测) 键进入 XY 马达、传感器输出检测界面 (如右图所示)。若上电后不进入准备状态且在该界面下不按  进行原点检索，可以直接通过方向键驱动马达移动，并显示出 XY 两传感器的 ON/OFF 状态，以检测 XY 马达驱动和传感器是否正常工作；若上电后进入准备状态，或在该界面按下过  进行原点检索，则每次进入该 I07 模式后，都需要先按  键进行原点检索后，才可以通过按方向键驱动 XY 马达移动，这种情况下表示对 XY 原点进行微调功能。左侧 X、Y 坐标显示的是原点偏移值，右侧 X、Y 坐标显示的是压脚框当前所处位置，按下  可将当前位置设置为原点参考值。



(8) 压脚马达/原点传感器检测

根据压脚原点传感器状态，A 位置显示压脚原点传感器的 ON/OFF 状态，B 位置显示剪线传感器的状态。

通过  和 ，压脚电机以 1 个脉冲 1 个脉冲进行驱动。

另外，按下  可驱动压脚电机到下述的定位置，显示该位置的图形为阴影。

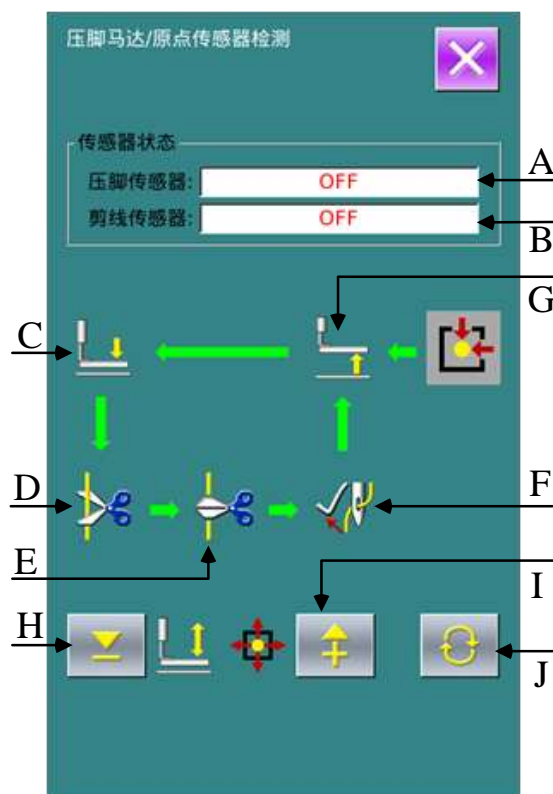

A: 压脚传感器 B: 剪线传感器

C: 压脚放下位置

D: 分线完成位置

E: 剪线完成位置

F: 拨线完成位置

G: 压脚抬起位置

H: 正向运动一步



J: 运动到下一位置

I: 反向运动一步

注：用启动开关进行压脚·切线电机原点检索之后，变为有效。

(9) 抓线马达/原点传感器检测

根据压脚原点传感器状态, A 位置显示抓线传感器的 ON/OFF 状态, B 位置显示抓线原点传感器的状态。

通过  和  , 压脚电机以 1 个脉冲 1 个脉冲进行驱动。

另外, 按下  可驱动抓线电机到下述的定位置, 显示该位置的图形为阴影。

A: 抓线传感器 B: 抓线原点传感器

G: 待机位置

C: 待抓位置

D: 抓紧位置

F: 松开位置

H: 正向运动一步

I: 反向运动一步

J: 运动到下一位置

注: 用启动开关进行抓线电机原点检索之后, 变为有效。

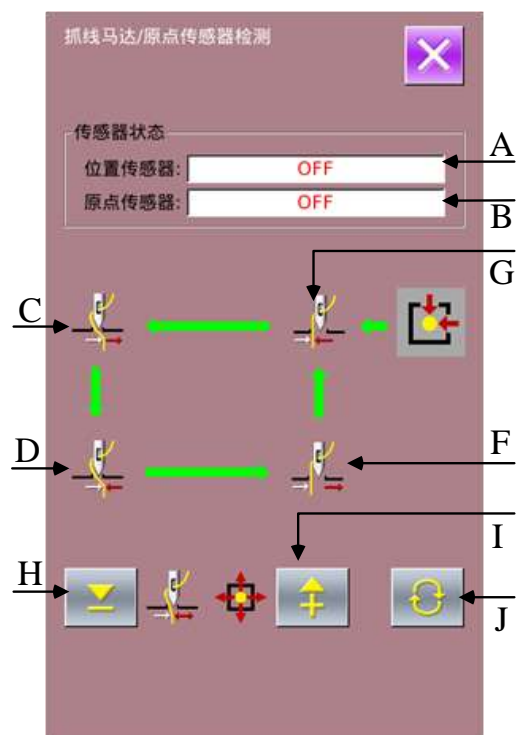

8.11 锁键盘操作

在设置模式等级 2 下，按下  进入锁键盘设置界面。

① 锁键盘操作



：未设定锁键盘状态



：已设定锁键盘状态

选择 ，按下  完成锁键盘操作。

按退出键  退出锁键盘操作。



② 锁键盘状态显示

关闭参数设置模式界面，返回数据输入界面，如右图，可以看到花样号码下方有一个显示锁键盘状态的图标 。在锁键盘状态下仅显示可使用图标。

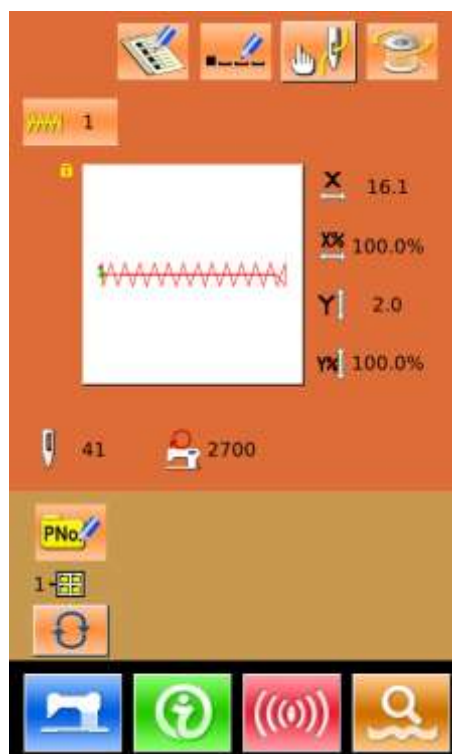

③ 键盘锁定范围

1、普通缝数据输入界面：

- 1) 花样登记
- 2) 花样命名
- 3) 放大缩小率设置
- 4) 最高转速限制
- 5) P 花样登记
- 6) 花样删除

2、普通缝制界面：

- 1) 移框
- 2) 计数器设置

3、P 花样输入界面：

- 1) P 花样编辑
- 2) P 花样复制
- 3) P 花样命名
- 4) 花样删除

4、P 花样缝制界面：

- 2) 计数器设置

5、C 花样数据输入界面：

- 1) C 花样登记
- 2) C 花样复制
- 3) C 花样命名
- 4) C 花样编辑
- 5) 花样删除

6、C 花样缝制界面：

- 2) 计数器设置

7、参数设置模式：

- 1) 参数 1 级
- 2) 参数 2 级
- 3) 计数器编辑
- 4) 检测模式
- 5) 花样锁定设置

8.12 参数备份设置





在设置模式等级 3 下，按  键进入参数还原备份界面，如右图所示：

清除键：清除全部已经保存的自定义参数

保存键：保存当前参数

恢复键：恢复当前参数



① 点击  ~  其中任意一键，以确定参数保存位置，然后点击「保存」键进行保存。

② 观察「自定义参数 xx (有/无)」键显示内容，如果括号内显示为「有」的则表示该位置上存储了用户参数。例如 .

③ 选择已经存储参数的自定义参数键，按下「恢复」键就会重新加载相应的参数设定值。

④ 按下「清除」键会清除全部已存参数。

8.13 钉扣机型设置

① 参数设置操作



在设置模式等级 3 下，选择  进入二级参数设置界面（如右图所示）。操作方法参照一级或二级参数设置。

选择 K241 进下一界面。





右图为机型选择界面，通过键盘选择数字 7，即为选择为钉扣功能。

按下  则结束选择。

注：更换机型后会清除掉系统已存储的花样，然后重新加载新机型花样，更换机型前请注意备份花样。



此时出现提示界面，如右图所示，按下退出键  则取消设置，按下  则进入确定清除掉旧机型已存花样。



成功清除掉旧机型花样后，需要关闭电源，如右图所示。



关闭电源重新启动后,会出现加载新机型花样的提示界面,如右图所示,按下确定键  即可。



成功加载了机型基础花样之后,系统进入到 N 花样主界面,如右图所示。

钉扣功能设置成功!



8.14 花样编辑参数设置

在设置模式等级 3 下，按下  可以进入花样编辑参数设置界面。

带有阴影效果的凹下图标表示该功能被打开，不带有阴影效果的凸起图标表示该功能被禁止。

根据需要设置编辑参数，按下确定键  完成设置。



9 电控系统原理

9.1 控制系统组成

9.1.1 电控箱安装尺寸

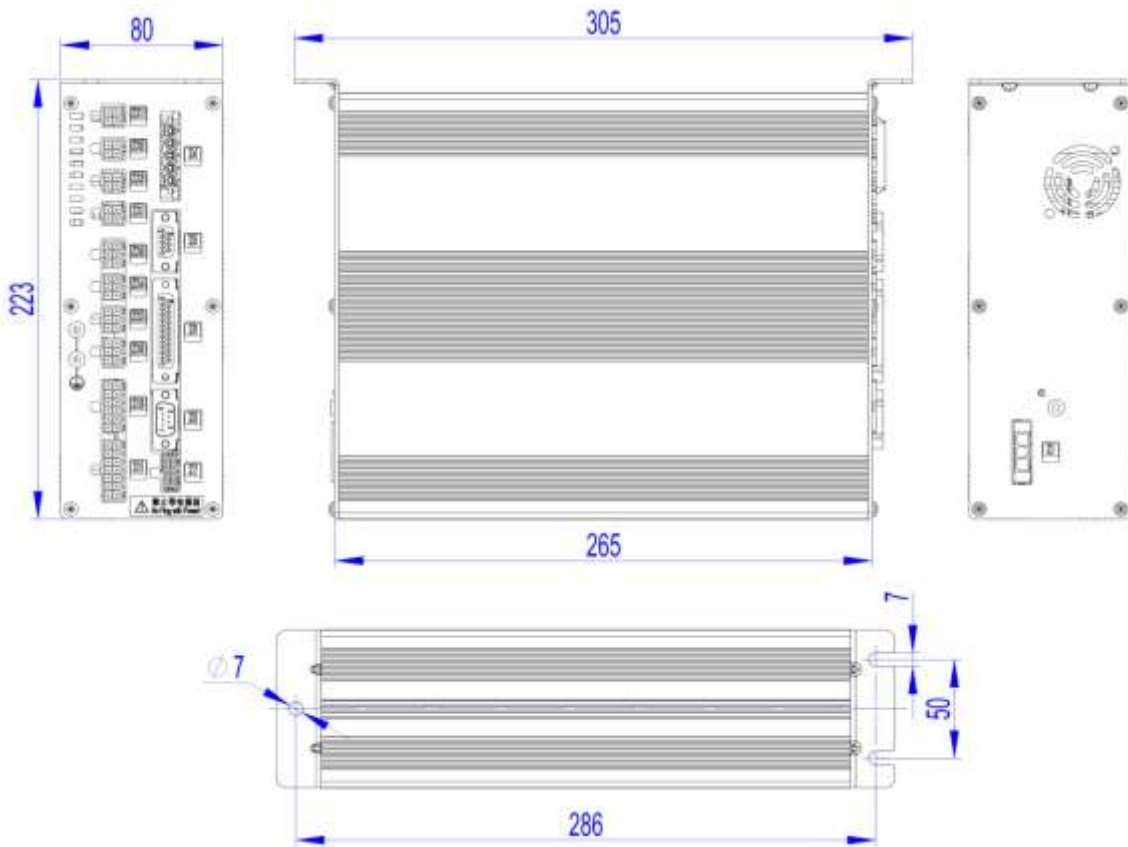

9.1.2 操作头安装尺寸

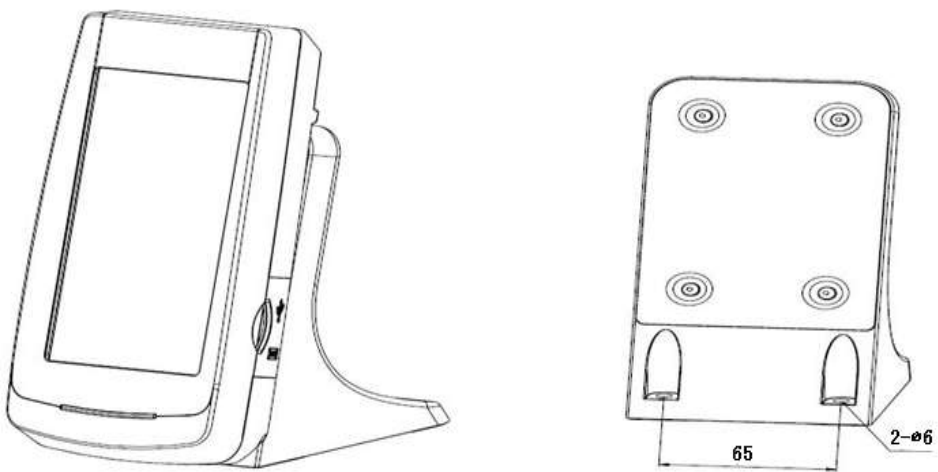

9.1.3 系统框图

1、MASC20X-2E-A 系统框图

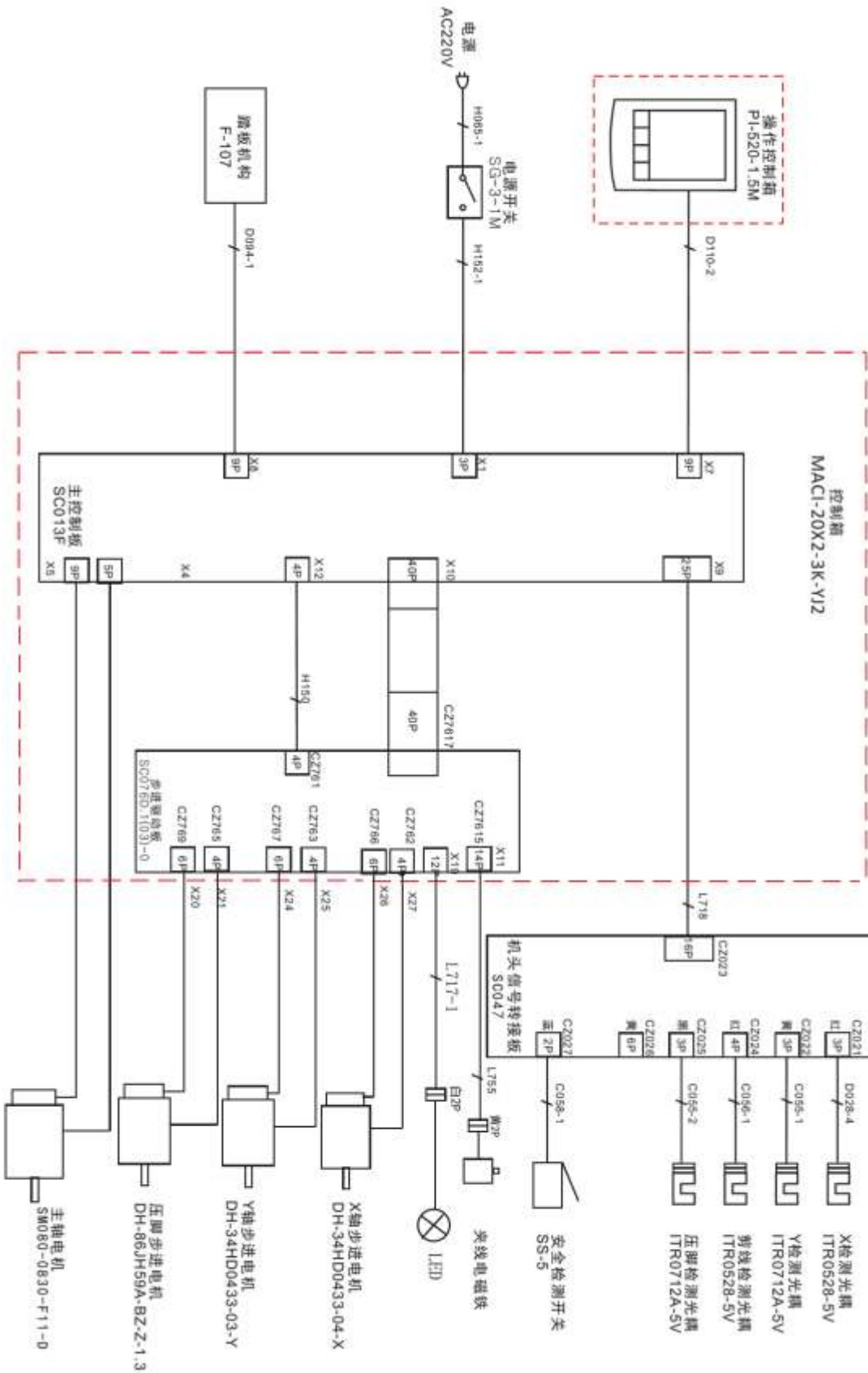

2、MSC20X-2E-A 系统框图

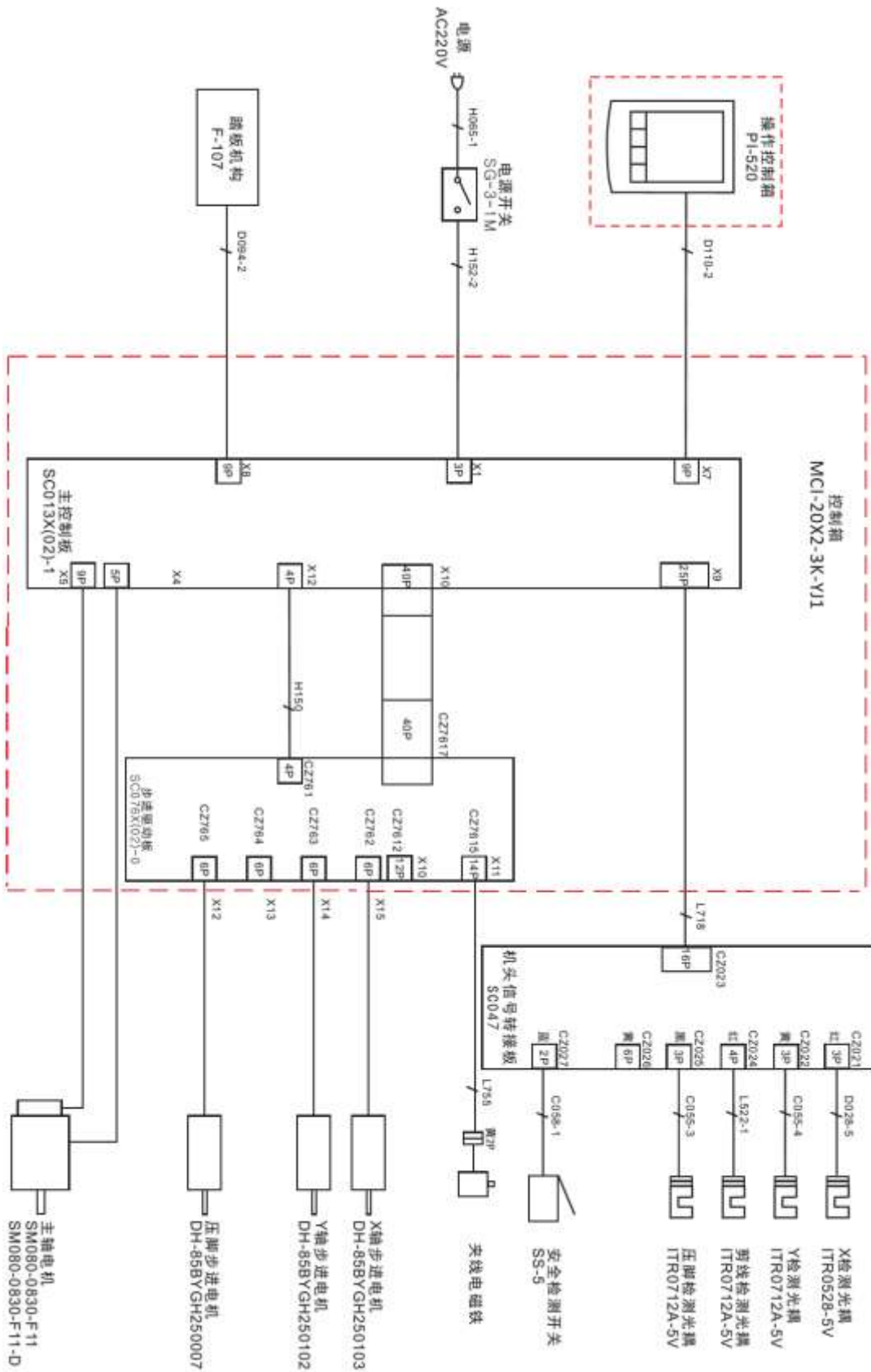

3、TSC20X-2E-A 系统框图

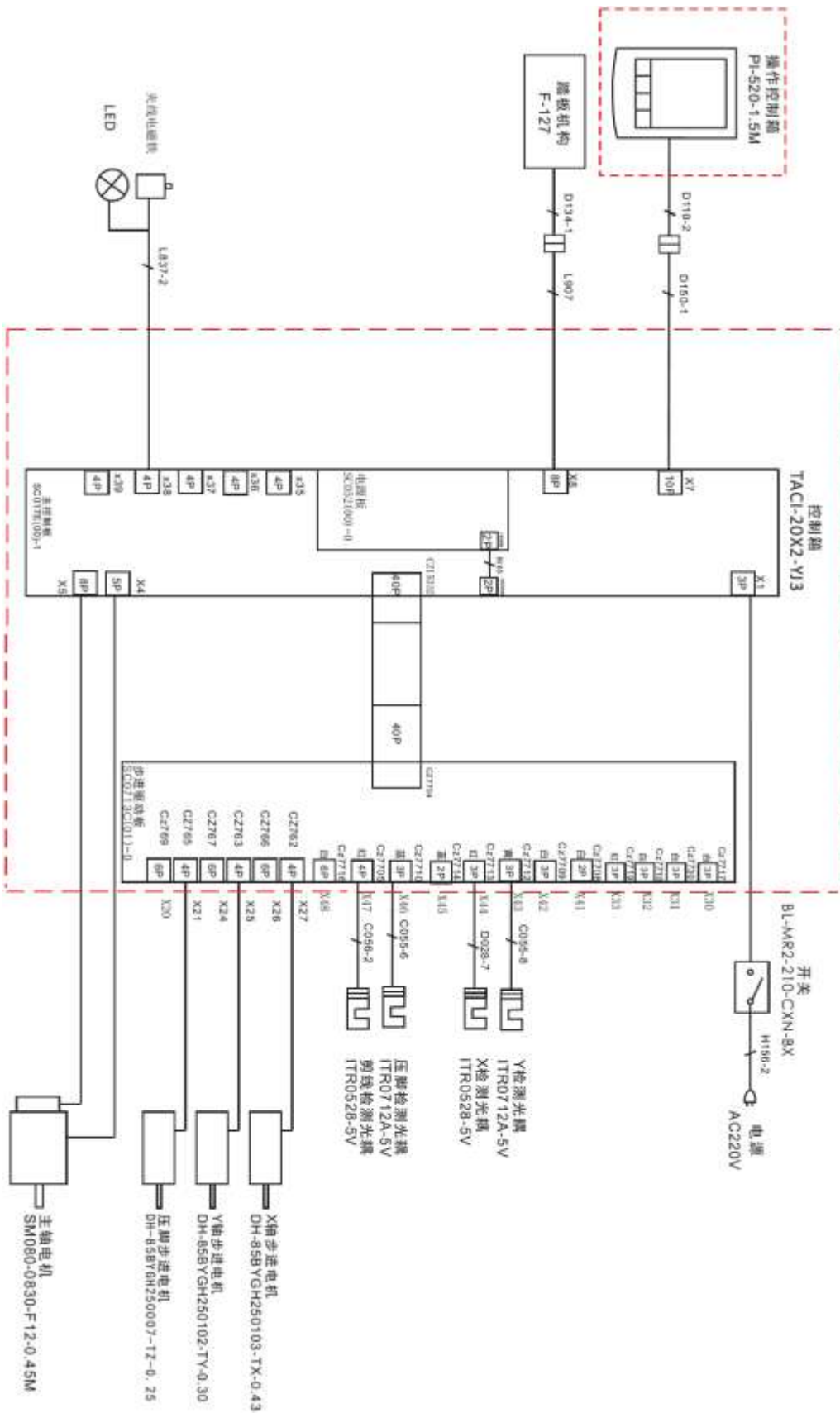

9.1.4 控制箱的外部线缆连接

1、MSC201 电控箱后板接线图

注：外部线缆插头上有对应的编号，请仔细查看后对应接插，参照示意图。

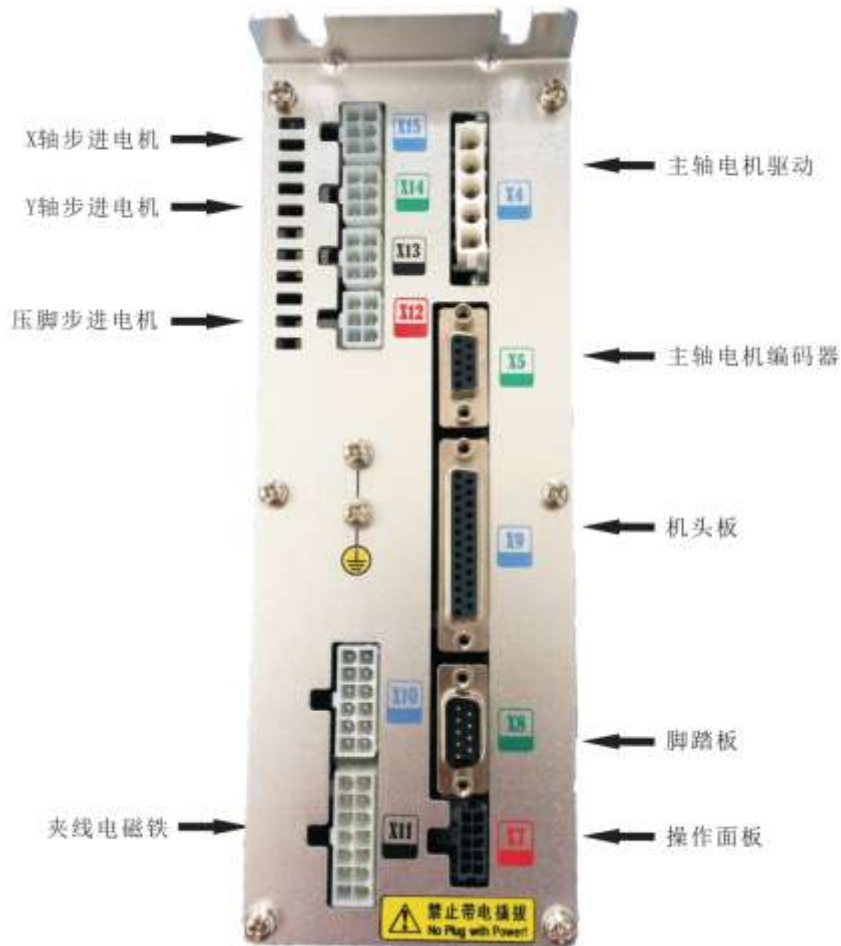



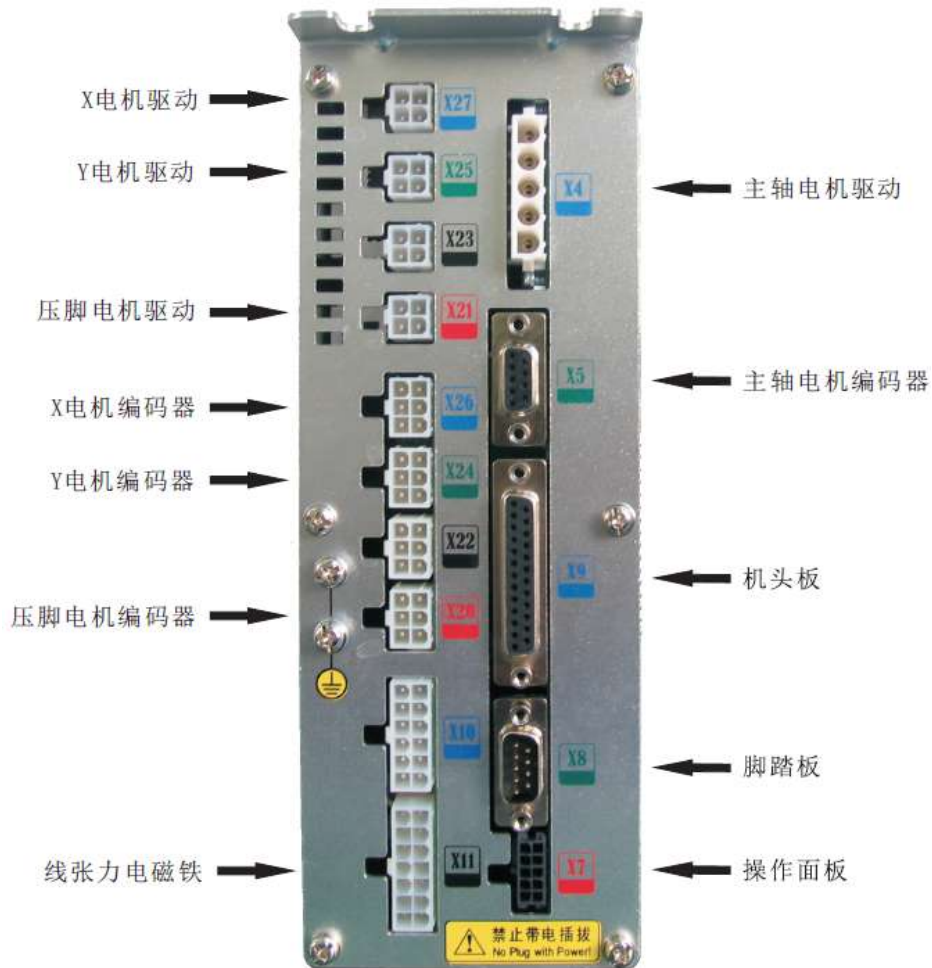





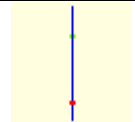
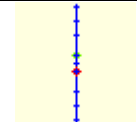
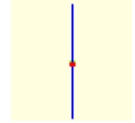
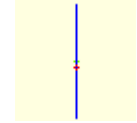

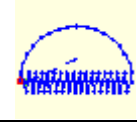
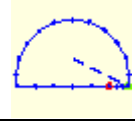
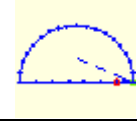
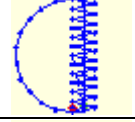
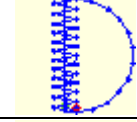

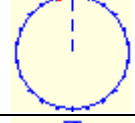
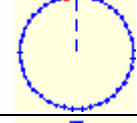
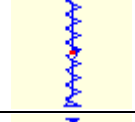
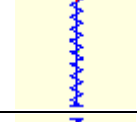
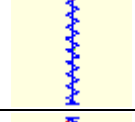

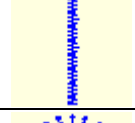
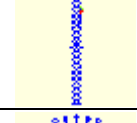
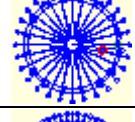
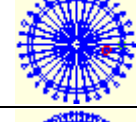
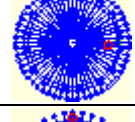
2、MASC201 电控箱后板接线图

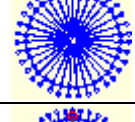

9.2 1900A 套结机花样一览表

NO.	缝纫图案	针数	长 × 宽 (mm)	NO.	缝纫图案	针数	长 × 宽 (mm)
1		41	16.1×2	2		41	10.2×2
3		41	16×2.4	4		41	24×3
5		27	10.1×2	6		27	16×2.4
7		35	10.1×2	8		35	16×2.4
9		55	24×3	10		63	24×3
11		20	6.1×2.4	12		27	6.2×2.4
13		35	6.1×2.4	14		14	8×2
15		20	8×2	16		27	8×2
17		20	10×0	18		27	10×0
19		27	25.2×0	20		35	24.8×0
21		40	25.2×0	22		43	35×0
23		27	4×20	24		35	4×20
25		41	4×20	26		55	4×20

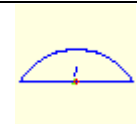
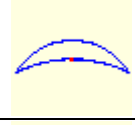
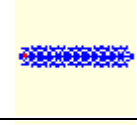
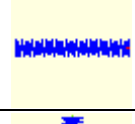
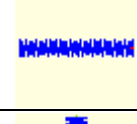
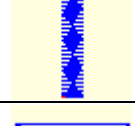
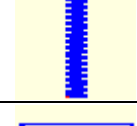
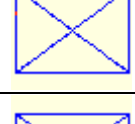
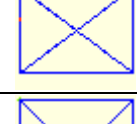
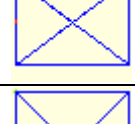
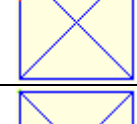
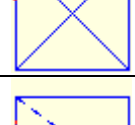
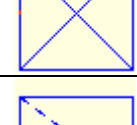
27		17	0×20	28		20	0×10
29		20	0×20	30		27	0×20
31		51	10.1×7	32		62	12.1×7
33		23	10.2×6	34		30	12×6
35		47	7×10	36		47	7×10
37		89	24×3	38		27	8×2
39		25	11.8×12	40		45	12×12
41		28	2.4×20	42		38	2.4×25
43		38	2.4×25	44		57	2.4×30
45		75	2.4×30	46		41	2.4×30
47		89	8×8	48		98	8×8
49		147	8×8	50		163	8×8
51		110	7.9×7.9	52		120	7.9×7.9
53		130	7.9×7.9	54		51	12.4×10. 2

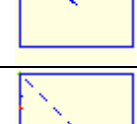
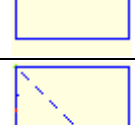
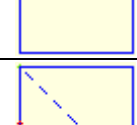
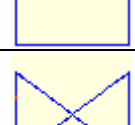
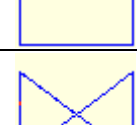
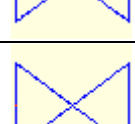
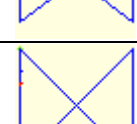
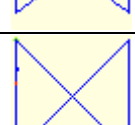
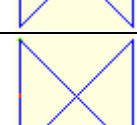
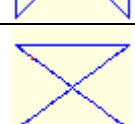
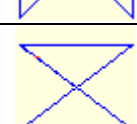
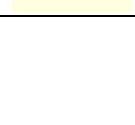
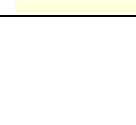
55		50	12.4×10. 2	56		52	21×6
57		57	21×6	58		102	19×3
59		115	40×5	60		115	40×5
61		93	5×30	62		109	5×30
63		108	40×30	64		80	40×30
65		64	40×30	66		96	30×30
67		76	30×30	68		60	30×30
69		52	40×30	70		40	40×30
71		32	40×30	72		44	30×30
73		36	30×30	74		28	30×30
75		60	40×30	76		48	40×30
77		36	40×30	78		56	30×30
79		44	30×30	80		36	30×30
81		67	40×30	82		51	40×30

83		39	40×30	84		55	30×30
85		35	30×30	86		42	30×30
87		32	30.1×30	88		26	30×30
89		74	20×24	90		54	20×24
91		65	20×20	92		49	20×20
93		39	20×20	94		63	25×20
95		51	25×20	96		45	25×20
97		42	25×20	98		33	25×20
99		27	25×20	100		88	30×25











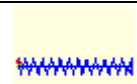

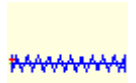

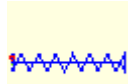

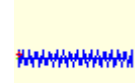
9.3 钉扣机花样一览表

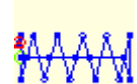
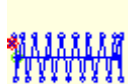





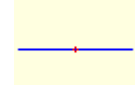
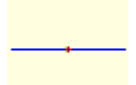
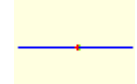
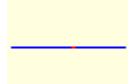
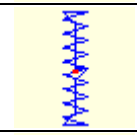
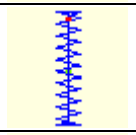
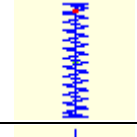
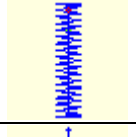



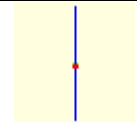
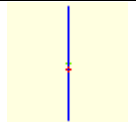
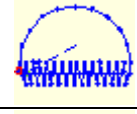

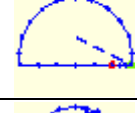
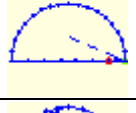
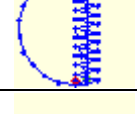

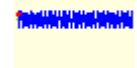

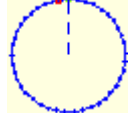
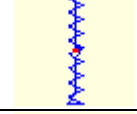
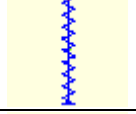
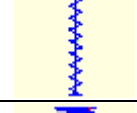
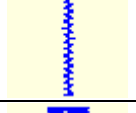
图案号	缝制图案	缝线 (根)	标准缝 制长度	标准缝 制长度	图案号	缝制图案	缝线 (根)	标准缝 制长度	标准缝 制长度

			X(mm)	Y(mm)				X(mm)	Y(mm)
1 • 34		6-6	3.4	3.4	18 • 44		6	3.4	0
2 • 35		8-8			19 • 45		8		
3		10-10			20		10		
4		12-12			21		12		
5 • 36		6-6			22		16		
6 • 37		8-8			23 • 46		6	0	3.4
7		10-10			24		10		
8		12-12			25		12		
9 • 38		6-6			26 • 47		6-6	3.4	3.4
10 • 39		8-8			27		10-10		
11		10-10			28 • 48		6-6		
12 • 40		6-6			29		10-10		
13 • 41		8-8			30 • 49		5-5-5	3.0	2.5
14		10-10			31		8-8-8		
15 • 42		6-6			32 • 50		5-5-5		
16 • 43		8-8			33		8-8-8		
17		10-10							

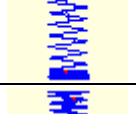





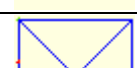
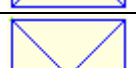



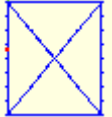
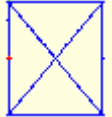

9.4 1906A 套结花样一览表

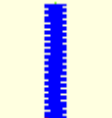
NO.	缝纫图案	针数	长 × 宽	NO.	缝纫图案	针数	长 × 宽
-----	------	----	-------	-----	------	----	-------

			(mm)				(mm)
1		41	16.1×2	2		41	10.2×2
3		41	16×2.4	4		41	24×3
5		27	10.1×2	6		27	16×2.4
7		35	10.1×2	8		35	16×2.4
9		55	24×3	10		63	24×3
11		20	6.1×2.4	12		27	6.2×2.4
13		35	6.1×2.4	14		14	8×2
15		20	8×2	16		27	8×2
17		20	10×0	18		27	10×0
19		27	25.2×0	20		35	24.8×0
21		40	25.2×0	22		43	35×0
23		27	4×20	24		35	4×20
25		41	4×20	26		55	4×20
27		17	0×20	28		20	0×10

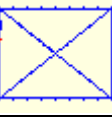
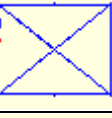
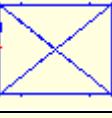
29		20	0×20	30		27	0×20
31		51	10.1×7	32		62	12.1×7
33		23	10.2×6	34		30	12×6
35		47	7×10	36		47	7×10
37		89	24×3	38		27	8×2
39		25	11.8×12	40		45	12×12
41		28	2.4×20	42		38	2.4×25
43		38	2.4×25	44		57	2.4×30
45		141	10×30	46		122	10×30
47		97	10×30	48		109	10.1×30
49		122	10.1×30	50		265	10×30
51		108	40×30	52		80	40×30
53		64	40×30	54		96	30×30
55		76	30×30	56		60	30×30

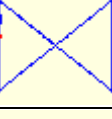
57		52	40×30	58		40	40×30
59		32	40×30	60		44	30×30
61		36	30×30	62		28	30×30
63		60	40×30	64		48	40×30
65		36	40×30	66		56	30×30
67		44	30×30	68		36	30×30
69		67	40×30	70		51	40×30
71		39	40×30	72		55	30×30
73		43	30×30	74		35	30×30
75		42	30×30	76		32	30.1×30
77		26	30×30	78		103	30×25
79		82	30×25	80		64	30×25
81		80	20×30	82		60	20×30
83		80	30×20	84		60	30×20

85		74	20×24	86		54	20×24
87		115	40×5	88		115	40×5
89		93	5×30	90		109	5×30
91		65	20×20	92		49	20×20
93		39	20×20	94		63	25×20
95		51	25×20	96		45	25×20
97		42	25×20	98		33	25×20
99		111	60×40	100		91	60×40

9.5 报警信息一览表

故障号	故障名称	复位方法
E-001	踏板未在正确位置。	请调整踏板位置。
E-002	机器进入急停状态	请检查急停开关状态。
E-003	确认机头放倒	
E-004	主电压（300V）过低	请关闭电源，检查系统硬件。
E-005	主电压（300V）过高	
E-007	IPM 过压或过流	请关闭电源，检查系统硬件。
E-008	辅助设备电压（24V）过高	请关闭电源，检查系统硬件。
E-009	辅助设备电压（24V）过低	请关闭电源，检查系统硬件。
E-010	气阀（风扇）故障	请关闭电源，检查系统硬件。
E-012	压脚位置异常	请关闭电源，检查系统硬件。

故障号	故障名称	复位方法
E-013	编码器故障或未连	请关闭电源，检查系统硬件。
E-014	电机运行异常	请关闭电源，检查系统硬件。
E-015	移动过程中超出缝制范围	请按下确定键解除故障。
E-016	针杆上位置异常	请按下确定键解除故障。
E-017	断线检测异常	请按下确定键解除故障。
E-018	剪刀位置异常	请关闭电源。
E-019	急停开关未在正常位置	请检查急停开关
E-020	步进软件版本错误	请关闭电源。
E-021	机器进入急停状态 (Free)	请检查急停开关状态。
E-022	机器进入急停状态 (Ready)	请检查急停开关状态。
E-023	抓线位置异常	请关闭电源。
E-024	操作头与缝纫机连接错误	请关闭电源。
E-025	X 原点检测异常	请关闭电源。
E-026	Y 原点检测异常	请关闭电源。
E-027	压脚原点检测异常	请关闭电源。
E-028	抓线原点检测异常	请关闭电源。
E-029	中压脚原点检测异常	请关闭电源。
E-030	步进驱动器通讯异常	请关闭电源。
E-031	步进电机过流	请关闭电源。
E-032	步进驱动电源异常	请关闭电源。
E-034	异常电流	请关闭电源。
E-035	IPM 频繁过流 1	请关闭电源。
E-036	IPM 频繁过流 2	请关闭电源。
E-037	电机堵转 1	请关闭电源。
E-038	电机堵转 2	请关闭电源。
E-039	电机超速	请关闭电源。
E-040	停车过流	请关闭电源。
E-041	电机过载	请关闭电源。

故障号	故障名称	复位方法
E-042	母线电压异常	请关闭电源。
E-043	剪线电机原点异常	请关闭电源。
E-044	机头板 EEPROM 读取错误	
E-045	器件异常	请关闭电源。
E-046	CRC 校验错误	请关闭电源。
E-047	数据校验错误	请关闭电源。
E-048	X 校验错误	请关闭电源。
E-049	Y 校验错误	请关闭电源。
E-050	MD1 步进过流	请关闭电源。
E-051	MD1 X 方向未走完	请关闭电源。
E-052	MD1 Y 方向未走完	请关闭电源。
E-053	MD2 步进过流	请关闭电源。
E-054	MD2 X 方向未走完	请关闭电源。
E-055	MD2 Y 方向未走完	请关闭电源。
E-056	步进闭环 DSP1 通信错误	请关闭电源。
E-057	步进闭环 DSP1 第一路 (X27) 过流	请关闭电源。
E-058	步进闭环 DSP1 第一路 (X27) 超差	请关闭电源。
E-059	步进闭环 DSP1 第一路 (X27) 超速	请关闭电源。
E-060	步进闭环 DSP1 第二路 (X25) 过流	请关闭电源。
E-061	步进闭环 DSP1 第二路 (X25) 超差	请关闭电源。
E-062	步进闭环 DSP1 第二路 (X25) 超速	请关闭电源。
E-063	步进闭环 DSP2 通信错误	请关闭电源。
E-064	步进闭环 DSP2 第一路 (X23) 过流	请关闭电源。
E-065	步进闭环 DSP2 第一路 (X23) 超差	请关闭电源。
E-066	步进闭环 DSP2 第一路 (X23) 超速	请关闭电源。
E-067	步进闭环 DSP2 第二路 (X21) 过流	请关闭电源。
E-068	步进闭环 DSP2 第二路 (X21) 超差	请关闭电源。
E-069	步进闭环 DSP2 第二路 (X21) 超速	请关闭电源。

故障号	故障名称	复位方法
E-070	步进板 90V 电源过流	请关闭电源。
E-071	升降机头位置错误	请关闭电源。
E-072	随动中压脚电机原点检测异常	请关闭电源。
E-073	XY 针距过大	请关闭电源。
E-074~89	步进驱动升级失败	
E-090	查询步进状态超时	
E-091	步进驱动版本错误	
E-092	步进驱动机型错误	
E-093	步进闭环 DSP1 (X25/27) 通信数据包校验错误	
E-094	步进闭环 DSP1 (X25/27) 通信数据包非法命令	
E-095	步进闭环 DSP2 (X21/23) 通信数据包校验错误	
E-096	步进闭环 DSP2 (X21/23) 通信数据包非法命令	
E-097	主控软件与主板硬件类型不符	
E-098	步进驱动 DSP1 曲线 CRC 校验错误	
E-099	步进驱动 DSP2 曲线 CRC 校验错误	
E-100	系统参数版本改变, 自动初始化全部默认系统参数	
E-101	系统参数范围异常	
E-254	未定义错误	通讯出现未定义错误

9.6 信息提示一览表

信息号	信息名称	子信息内容
M-001	花样数据不存在	请重新读取或打版输入。
M-002	设定值太大	请输入范围内数值。
M-003	设定值太小	请输入范围内数值。
M-004	存储参数异常	请按下确定键恢复出厂值。
M-005	通讯错误	操作头与控制箱通讯异常!
M-006	字母绣字库文件读取失败	
M-007	操作头与控制箱类型不符	请核对机型和软件版本
M-008	超过最大针距	

信息号	信息名称	子信息内容
M-009	密码错误	请重新输入。
M-010	硬件时钟故障	发现硬件时钟故障，请联系厂家维修！
M-011	字母绣花样保存成功	请进入花样选择界面下选择新生成的字母绣花样
M-012	SRAM 初始化	清除掉 SRAM 中全部数据，请关电并将拨码开关位置还原
M-013	关机，再见！	
M-014	USB 盘已拔出	USB 盘已经拔出！
M-015	U 盘中没有发现花样数据	
M-016	至少输入一个字母	字母绣打版需要至少输入一个字母！
M-017	无报警记录	
M-018	输入用户 ID 有误	请重新输入
M-019	确认密码失败	请重新输入密码
M-020	禁止修改系统时间	设置了分期密码，不能修改系统时间
M-021	密码文件写入失败	
M-022	密码文件读取失败	
M-023	密码保存成功	
M-024	清除全部密码失败	密码文件无法被删除
M-025	清除密码失败	清除密码后，文件写入异常
M-026	密码文件被恶意删除	用户设置的分期密码被恶意删除，请关机
M-027	用户 ID 文件损坏	
M-028	输入不能为空	请输入密码
M-029	当前密码不符	请重新输入当前密码
M-030	新密码不一致	请重新输入新密码并再次确认
M-031	确定进入触摸屏校正模式？	是否确定？ 是：Enter 否：X
M-032	触摸屏校正成功	校正成功，请关闭电源后重启
M-033	触摸屏校正失败	请重新校正
M-034	确定清除报警记录？	是否确定？ 是：Enter 否：X
M-035	分期密码不能和总密码相同	请重新输入密码
M-036	花样数据错误	当前花样数据错误，将由出厂花样替换！

信息号	信息名称	子信息内容
M-037	花样信息文件打开失败	恢复出厂花样配置!
M-038	花样个数已满	请删除不用的花样后再执行操作!
M-039	是否覆盖花样	是否确定? 是: Enter 否: X
M-040	P 花样打开失败	花样文件错误, 将会被删除!
M-041	C 花样打开失败	花样文件错误, 将会被删除!
M-042	花样已存在	不能执行覆盖操作!
M-043	是否删除花样数据	按下确定键执行删除操作, 按下取消键退出当前操作。
M-044	是否删除选中的文件	是否确定? 是: Enter 否: X
M-045	花样被引用, 不能删除!	请在 P 花样或 C 花样中解除引用
M-046	请至少保留一个花样!	最后一个花样不能被删除
M-047	加载出厂花样	内存中没有花样, 需要加载出厂花样
M-048	内存中没有花样	按确定键加载出厂花样
M-049	输入号码不存在	请重新输入
M-050	P 花样不存在	请先创建 P 花样
M-051	保存软件版本成功	软件版本已经成功保存到 U 盘根目录下
M-052	更换机针	更换机针设定值已到达, 请更换机针!
M-053	更换机油	更换机油时间设定值已到达, 请更换机油!
M-054	清扫机器	清扫机器时间设定值已到达, 请清扫机器!
M-055	确定清除更换机针计数值?	是否确定? 是: Enter 否: X
M-056	确定清除更换机油计数值?	是否确定? 是: Enter 否: X
M-057	确定清除清扫时间计数值?	是否确定? 是: Enter 否: X
M-058	确定清除生产管理计数值?	是否确定? 是: Enter 否: X
M-059	确定清除累积运转时间?	是否确定? 是: Enter 否: X
M-060	确定清除累积缝纫件数?	是否确定? 是: Enter 否: X
M-061	确定清除累积上电时间?	是否确定? 是: Enter 否: X
M-062	确定清除累积缝纫针数?	是否确定? 是: Enter 否: X
M-063	确定清除累积过流次数?	是否确定? 是: Enter 否: X
M-064	确定清除累积停车错误次数?	是否确定? 是: Enter 否: X

信息号	信息名称	子信息内容
M-065	是否编辑新花样?	是否确定? 是: ↓ 否: X
M-066	是否返回缝制模式?	是否确定? 是: ↓ 否: X
M-067	是否还原所有设定	是否确定? 是: Enter 否: X
M-068	是否还原选择项目	是否确定? 是: Enter 否: X
M-069	未选择项目	请选择一个或几个参数项
M-070	缝制计数器达到设定值	请按下确定键清除
M-071	计件计数器达到设定值	请按下确定键清除
M-072	成功	已成功执行当前操作!
M-073	失败	当前操作执行失败!
M-074	拷贝文件失败	请检查磁盘空间是否已满!
M-075	拷贝文件失败	请检查是否拔出了 USB 盘!
M-076	文件读写错误	文件读写错误!
M-077	升级程序文件校验失败	
M-078	花样数据不能删除	被选中的缝制数据正在使用!
M-079	是否执行参数传输操作	是否确定? 是: Enter 否: X
M-080	转换花样无法打开	请确认花样文件
M-081	转换花样格式错误	请确认花样文件
M-082	转换花样数据超长	请确认花样文件
M-083	升级成功	升级成功, 请重新启动机器
M-084	打开文件失败	U 盘中打开文件失败
M-085	恢复参数成功	恢复参数成功, 请重新启动机器
M-086	没有选中升级条目	请选中要升级的条目, 至少要选中一个条目
M-087	选中的升级条目中有些不存在	不存在升级文件的条目返回后将会取消选中, 如果要升级剩下的条目, 请再次确认
M-088	是否格式化 U 盘	按下确定键执行格式化操作, 按下取消键退出当前操作 格式化后会删除全部 U 盘文件
M-089	是否格式化内存	按下确定键执行格式化操作, 按下取消键退出当前操作 格式化后会删除全部内存花样数据
M-090	内存空间不足	
M-091	不能选择该功能	

信息号	信息名称	子信息内容
M-092	指定的形状点重复或存在相同的形状点	
M-093	不能执行回退操作	
M-094	没有下一针缝制数据	
M-095	没有上一针缝制数据	
M-096	花样数据太大	
M-097	运算异常	
M-098	打版通用错误	
M-099	花样不存在	
M-100	超过移动范围	
M-101	超出缝制范围	请确保花样数据在缝制范围以内
M-102	针数超出范围	请减少花样针数。
M-103	花样文件数据错误	花样文件损坏或者花样数据格式不符合标准
M-104	确认点改变	
M-105	确认自动插入剪线	
M-106	删除新编辑花样	确定键确认，退出键取消
M-107	删除要素	确定键确认，退出键取消
M-108	执行，确认吗？	确定键确认，退出键取消
M-109	删除机械控制命令？	确定键确认，退出键取消
M-110	删除落针点	确定键确认，退出键取消
M-111	移动压脚，确认吗？	确定键确认，退出键取消
M-112	删除形状点	确定键确认，退出键取消
M-113	警告：格式化将删除磁盘上的所有数据！	确定键确认，退出键取消
M-114	是否更换机型	更换机型后会删除掉全部花样，然后重新加载基础花样！
M-115	花样被锁定	请解锁后再使用
M-116	禁止修改基础花样！	
M-117	请关机	当前操作结束，请重新启动机器
M-118	禁止修改计数器	当修改时，请关闭设定
M-119	加载基础花样	请按下确认键加载基础花样，不要关机！

信息号	信息名称	子信息内容
M-120	是否恢复出厂设置	确定键执行操作，取消键退出操作
M-121	是否清除全部自定参数	是否确定？ 是：Enter 否：X
M-122	机头板参数异常	按下确定键恢复出厂值
M-123	花样计算错误	形状点在同一条直线上或者生成圆、圆弧的半径超出上限
M-124	是否删除全部 P 花样和 C 花样	按下确定键执行格式化操作，按下取消键退出当前操作。
M-125	确定恢复机头板参数？	是否确定？ 是：Enter 否：X
M-126	超出设定值范围	
M-127	自编花样不存在	当前操作仅支持自编花样, 基础花样不能导出!
M-128	外压脚在上	当前操作需要落下外压脚后执行!
M-129	不能进行正确操作	
M-130	USB 盘不存在	请插入包含 mp3 文件的 USB 盘
M-131	没有视频文件 video.avi	请将 video.avi 文件存放到 u 盘的 update 目录，并进入到升级界面升级视频文件
M-132	是否切换 1903 起缝加固基础花样	切换参数后会删除掉全部花样，然后重新加载基础花样!
M-133	缩放失败	针间距超出上下限
M-134	曲线生成失败	请重新输入
M-135	圆弧或圆生成失败	请重新输入
M-136	参数设置异常	生成的花样数据超出最大针长，请检查参数设置
M-137	长度或半径参数设置异常	1. 底缝长度超过套结长度， 2. 套结长度和底缝长度相比太长 3. 内径超过花样的外径 4. 半月高度低于套结针距或相对套结长度太高 5. 请检查参数设置
M-138	针距或针数设置异常	针距小于最小针距，请检查针距或针数设置
M-139	缝制数据超过最大针长	1. 底缝针距过大 2. 曲折缝针距过大 3. 请修改参数设置
M-140	主控版本过低	
M-141	基础花样错误，需要重新升级基础花样	
M-142	升级步进结束校验错误	
M-143	二维码显示失败	

信息号	信息名称	子信息内容
M-144	确定恢复步进参数?	是否确定? 是: Enter 否: X

1 General Information

1.1 General

This computerized control system for sewing machine features the following advantages: 1) Adoption of the world leading AC servo control technology on main shaft motor provides high torque, good efficiency, stable speed and low noise; 2) Diversified design of control panel can meet the special requirement of users on attachment; 3) System adopts German style structure, which offers easy installation and maintenance to users; 4) The system control software can be updated via the remote communication, which is easy for user to improve the performance of machine.

1.2 Technical Parameters

No.	Model	
	Items	20X
1	Usage	Doubling & Tacking, Button Sewing
2	Sewing Range	X(Left/ Right) Direction 40mm × Y(Forward/Backward) Direction 30mm
3	Max Speed	Max 3000rpm (For Double Hook type, it is 2700rpm)
4	Min Sewing Unit	0.1mm
5	Cloth-feeding	Indirect Cloth-feeding (Pulse Motor Dual-shaft Drive)
6	Stroke of Needle Rod	41.2mm
7	Needle	DP ×5 #14 (DP×5 #11(F,M), (DP×17#21 Thick Fabric))
8	Presser-lifting Device	Pulse Motor
9	Presser Height	Standard 14mm, Max 17mm(at Reverse Lifting)
10	Standard Pattern Number	50/100
11	Thread-wiping Method	Interaction by lifting presser with pulse motor
12	Needle Thread Tension	Electronic Thread-holder
13	Hook	Semi-rotation standard hook or Semi-rotation double hook
14	Oiling Method	Rotation Part: Slight Oiling
15	Oil	Sewing machine oil

16	Lubricating Grease	Lubricating grease for sewing machine
17	Data Memory	U Disk
18	Scaling Function	Independent scaling 20% ~200% at X direction and Y direction respectively (1% for each step)
19	Scaling Method	Change Stitch form length and stitch interval
20	Sewing Speed	400-3000rpm(100rpm per step)
21	Patten Selection	By selecting the number of pattern (1-200)
22	Bottom Thread Counter	Up/Down Method (0~9999)
23	Motor	500W Small AC Servo Motor (Direct Drive Mode)
24	Size	263mm×153mm×212mm
25	Weight of Control Box	About 10 Kg
26	Power	600W
27	Working Temperature	0°C~45°C
28	Working Humidity	35%~85% (No Dew)
29	Voltage Input	AC 220V ±10%; 50/60Hz

※ At daily usage, please lower the max sewing speed according to the sewing condition.

※ Effective standard for product:QCYXDK0004—2016 《Computerized Control System for Industrial Sewing Machine》.

1.3 Matters for Safe Using

● Installation

- Control Box
 - ◆ Please install the control box according to the instruction
- Attachments
 - ◆ If other attachments are needed, please turn off the power and pull off the power plug.
- Power Cable
 - ◆ Do not press power cable with force or excessively twist power cable.
 - ◆ The power cables shall be fixed with a distance at 25mm away from the rotating component at least
 - ◆ Before powering the control box, user shall carefully check the voltage of power supply and position of power input on control box. If the power transformer is used, user should also check it before powering the machine. At this moment, the power switch of sewing machine must be set as “Off”.
- Grounding

- ◆ In order to avoid the noise disturbance and shock caused by electrical leakage, user should ground the grounding cable.
- Attachments
 - ◆ If the electrical attachments are needed, please connect them to the proper positions.
- Disassemble
 - ◆ When removing the control box, user should turn off the power and pull off the power plug.
 - ◆ At pulling off the power plug, user should hold the plug and remove it, instead of pulling the power cable only.
 - ◆ The control box contains the dangerous high voltage power. For opening the control box, please turn off the power and take away the plug from socket firstly, and then wait for at least 5 minutes before opening the control box.

● **Maintenance, Inspection and Repair**

- Only can the trained technicians perform the repair and maintenance of this machine.
- When replacing the needles and shuttles, user has to turn off the power.
- Please use the spare parts from the authorized manufacturers

● **Others**

- Do not touch the rotating or moving part of the machine, especially the needle and belt, when the machine is working. User should also keep his/her hair away from those moving parts, so as to avoid the danger.
- Do not drop the control device on the floor, nor insert ant stuff into the slot on the control box.
- Do not run the machine without the cover shells
- If this control device is damaged or unable to work normally, please ask the technicians to adjust or repair it. Do not run the machine when the problem is not solved
- Please do not change or modify the control device without authorization

● **Abandonment**



- Dispose it as common industrial trash.

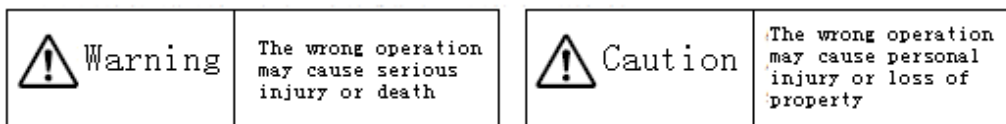

● **Warning and Danger**

- The mistake operation may cause danger. For the serious level, please refer to the figure at below





- The meaning of the figure are shown at below:

	Please operate machine according to instruction
	Caution: High Temperature
	Never do this.

	Caution: High Voltage
	Grounding is a must

1.4 The Preventions on Usage

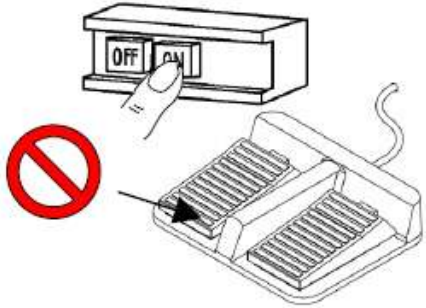
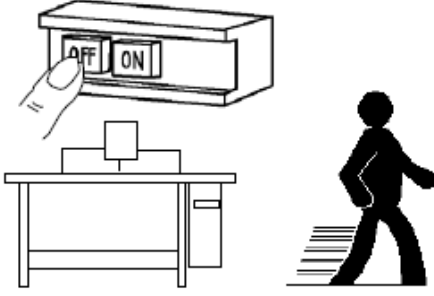
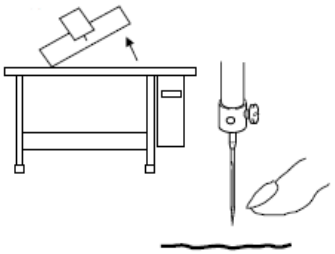
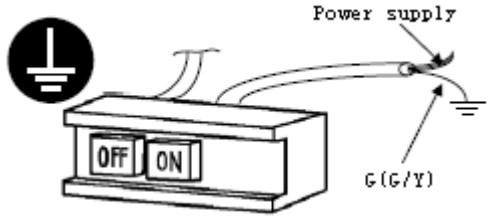
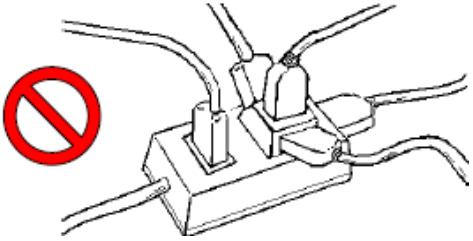
Warning

<p>1、 When you press [ON], leave the feet from pedal.</p> 	<p>2、 When you leave the machine, please turn it off.</p> 
<p>3、 If user needs tilt the head or replace the needle or thread the Needle thread, please turn off the power</p> 	<p>4、 Ground the machine with ground cable</p> 
<p>5、 Do not use the household terminal block to let machines to share one power supply</p> 	<p>6、 For opening the control box, please turn off the power and take away the plug from socket firstly, and then wait for at least 5 minutes before opening the control box</p> 

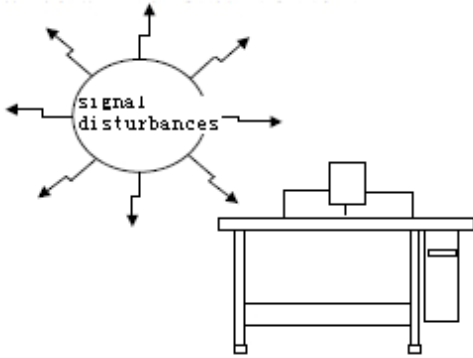
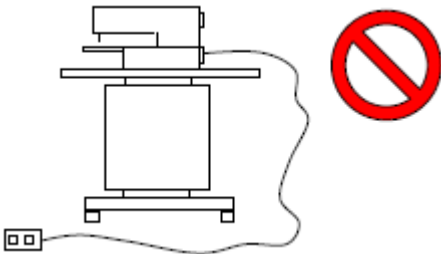
<p>7、 After replacing the motor, please set the installation angle of main motor according to this documents.</p>	
<p>8、 Please keep it away from the machine creating the high cyclic disturbance</p> 	<p>9、 If user needs the external signal socket to connect the attachments, the connecting wire shall be as short as possible. The long cable may cause the wrong operation. And the connection cable shall be the isolated cable</p> 
<p>10、 If the fuse is burnt, please solve the problem before replacing a new one with same capacity</p>	

1.5 Standardization

The button using the common figure can be understood by the users from different countries.

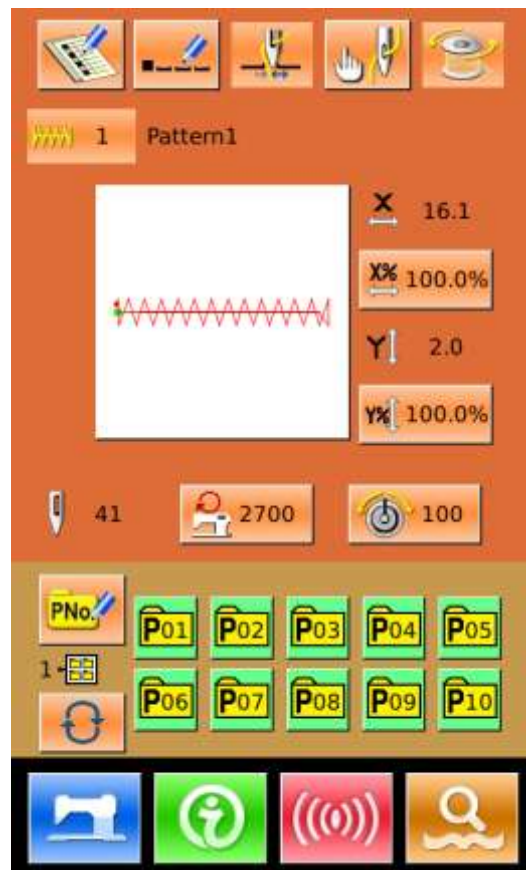

1.6 Operation Method

We use the advanced touching operation technique on the operation panel, whose friendly interface and simple operation will bring the big changes to users in their usage. Users can finish the relating operations by using their fingers or other object to touch the screen. **Never use sharp object to touch the screen, otherwise the touching panel will suffer the permanent damage.**

The function keys include Ready Key, Information Key, Mode Key and Communication Key. For the specific operation, please refer to the chapters at below:













Never use sharp object to touch the screen, otherwise the touching panel will suffer the permanent damage

2 Operating Instruction

2.1 Common Buttons

The buttons for the common operation in each interface are shown at below:

No.	Figure	Functions
1		ESC → Quit the current interface. At data change interface, it is for canceling the change of data.
2		Enter → Confirm the changed data.
3		Plus → Increase the value
4		Minus → Decrease the value
5		Reset → Release the Error
6		Number Input → Display the number keyboard and input the number.
7		READY Key → Shift between the data input interface and sewing interface
8		Information Key → Shift between the data input interface and information interface
9		Communication Key → Shift between the data input interface and communication interface
10		Mode Key → Shift between the data input interface and communication interface

2.2 Basic Operation

① Turn on the power

Turn on the power to display the data input interface.

② Select the wanted pattern No.

At current interface, the selected pattern No. will be



displayed. Press  to select pattern number.

For the operation of pattern selection, please refer to **【2.7 Pattern Selection】**.

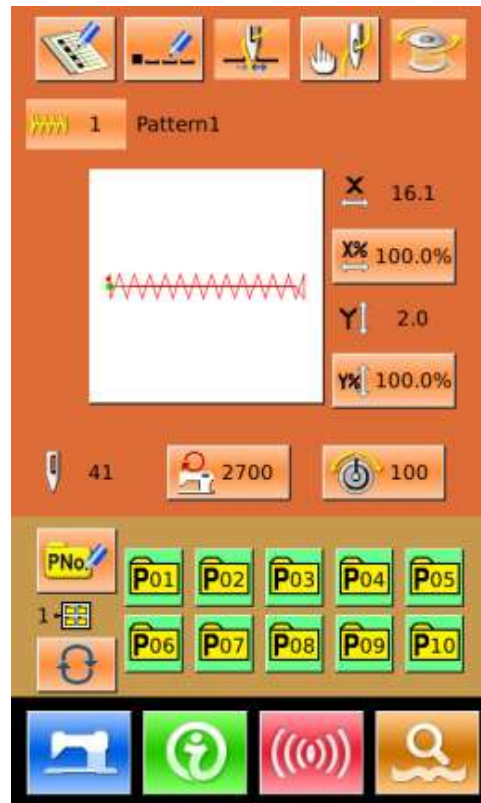

③ Set machine to Ready Sewing Status

Press READY key . The back-light of LCD displayer changes to blue color and the machine is ready for sewing.

④ Start Sewing

Set the sewing product to the presser position; operate the pedal to start the sewing machine, and sewing starts

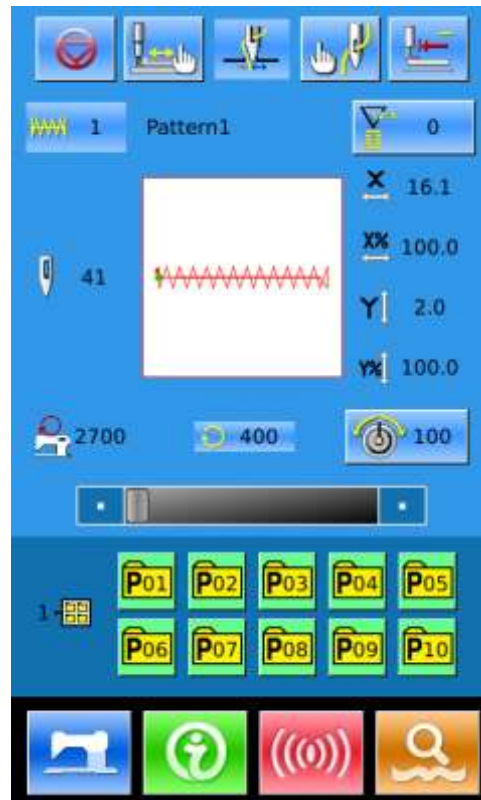

2.3 Operation of Normal Pattern

(1) Sewing Data Input Interface

The data input interface is shown at right. For the detailed functions, please refer to the Function Key List

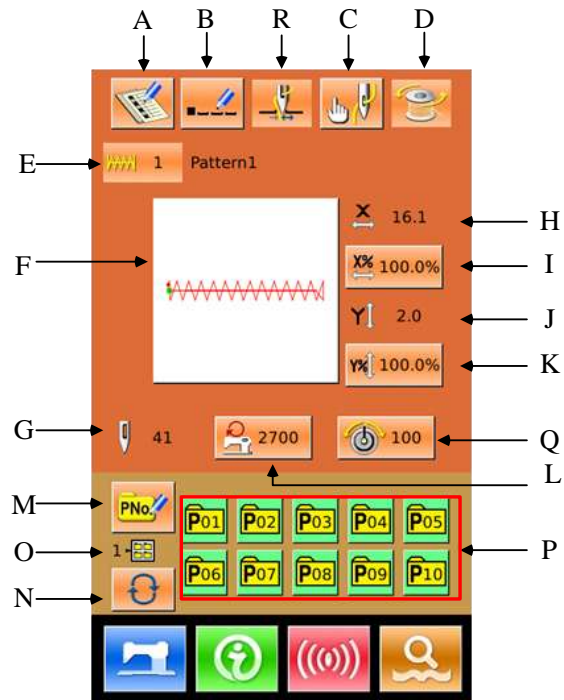

Function Key List:

No.	Function	Content
A	Pattern Registration	At most, 999 normal patterns can be registered.
B	Pattern Naming	At most, 14 figures can be input.
R	Thread-catching (Displayed according to the actual condition of machine)	Activate the thread-catching function. It is affected by parameter U35.
C	Threading	Lower the presser to display the interface. For lifting the presser, please press "Presser Up" button.
D	Winding	Press  to start winding.
E	Pattern No. Display	Display the current pattern number
F	Sewing Pattern Selection	The button will display the shape of the current pattern. Press it to enter the interface for selecting patterns

G	Pattern Stitch Number	Display stitch number of the current pattern
H	X Actual Size	Display the actual size of current pattern at X direction. Use parameter U64 to input the actual size, at this moment the X Actual Size button is displayed.
I	X Scale Rate	The button will display the X scale rate of the current pattern. Press it to enter the interface for setting. It is affected by parameters U64 & U88.
J	Y Actual Size	Display the actual size of current pattern at Y direction. Use parameter U64 to input the actual size, at this moment the Y Actual Size button is displayed.
K	Y Scale Rate	The button will display the Y scale rate of the current pattern. Press it to enter the interface for setting. It is affected by parameters U64 & U88.
L	Max Speed	Display the Max Speed. Press this button to set the speed
M	Prompt Pattern (P Pattern) Registration	It is used for P pattern registration. At most, 50 P patterns can be registered.
O	P Pattern File Folder Number	Display the file folder number of current P pattern
N	P Pattern File Folder Selection	Shift P pattern file folder number orderly.
P	P Pattern Selection	Display the registered P pattern. Press it to enter the interface for inputting P pattern data. This button is not displayed at initial status.
Q	Thread Tension Setting (this button is displayed according to the actual condition of machine)	Display the basic value of thread tension. Press button to set the value

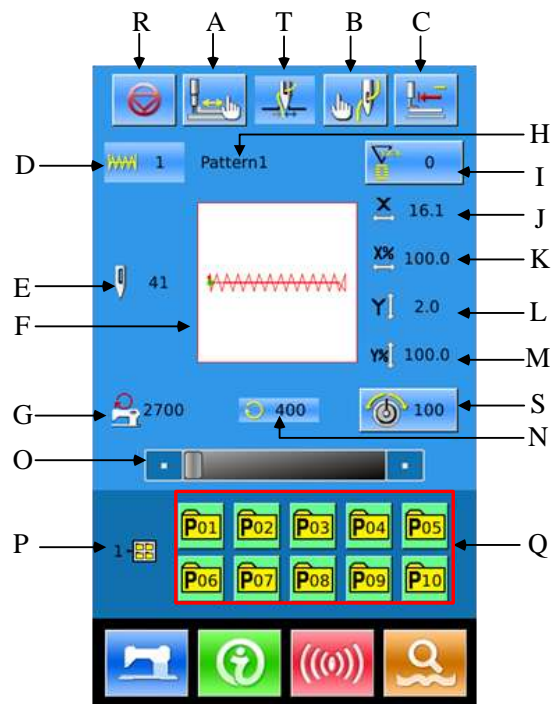

(2) Sewing Interface

Press  to enter the Sewing Interface shown as the figure at right. For detailed functions please take the Function Key List for reference.



Function Key List:

No.	Function	Content
A	Trial Sewing	Press it to enter the trial sewing interface, where the pattern shape can be set.
T	Thread-catching (Displayed according to the actual condition of machine)	Activate the thread-catching function. It is affected by parameter U35.
B	Presser Down	Lower presser to display the presser down interface. For lifting the presser, please press the “Presser Up” Button.
C	Return to Origin	Press it to have presser return to the start sewing point and go up.
D	Pattern Number	Display the number of the current pattern
E	Pattern Stitch Number	Display the stitch number of the current pattern
F	Pattern Shape	Display the shape of the current pattern

G	Max Speed	Display the Max Speed
H	Pattern Name	Display the name of the current pattern.
I	Counter Setting	Press it to set the counter type and current counter value  : Sewing Counter  : No. of piece counter
J	X Actual Size	Display the X actual size of current pattern
K	X Scale Rate	Display the X scale rate of current pattern
L	Y Actual Size	Display the Y actual size of current pattern
M	Y Scale Rate	Display the Y scale rate of current pattern
N	Sewing Speed	Display the current sewing speed
O	Set Sewing Speed	Change the sewing speed
P	P Pattern File Folder Number	Display the number of the current P pattern file folder
Q	P Pattern Selection	Display the registered P pattern. Press it to enter the interface for sewing P pattern. This button is not displayed at initial status.
R	Pause	Press it to stop the machine. It is affected by parameter U31. When this button is selected, the interface will only display this button
S	Thread Tension Setting (this button is displayed according to the actual condition of machine)	Display the basic value of thread tension. Press button to set the value

2.4 Pattern Registration

999 normal patterns can be registered for the

most. press  to enter the interface of Pattern Registration (shown as the right figure):

② Input Pattern No.

Input the pattern No. via keyboard. If the pattern number is already existed in the system, the look and relevant information of the registered pattern will be shown on

the upper interface. by pressing ,

 user can search the unregistered number.

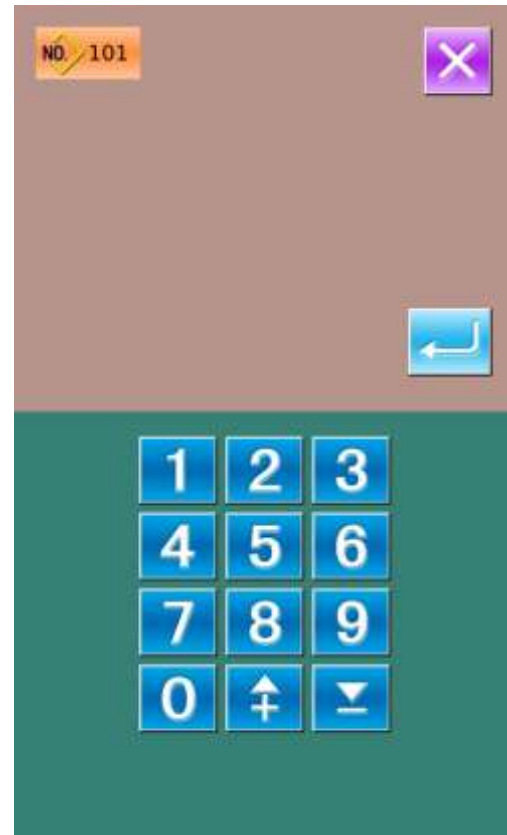

② New Pattern Registration

After confirming the pattern number, user can press . The displayed pattern data will be copied to the newly registered pattern. After the operations, the system will return to the interface for inputting data of the newly registered pattern

If user inputs the existed pattern number, the system will ask user whether to replace the saved pattern.

Note: the Basic pattern cannot be replaced

2.5 Pattern Naming

Press  to enter the interface for naming pattern (as shown in the right figure), 14 figures can be inputted at the most.

: Icon Right-moving

: Icon Left-moving

: Caps Locks

: Eraser

Select the figure wanted, press  to end the operation of naming the pattern.

The position of figure can be determined by moving the icon, the Eraser is used to delete the figure

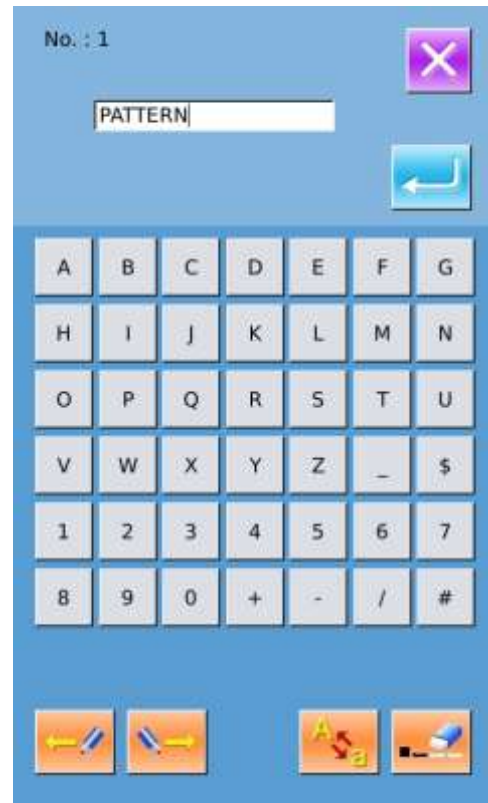

2.6 Winding

① Install the shuttle core

Fit the shuttle core fully onto the winder shaft. (as shown in the figure in right)

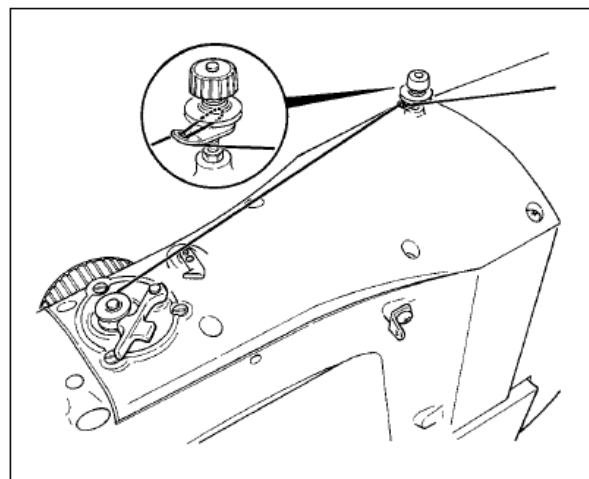

② Display the bottom thread winding screen

Press  in the data input interface, and then the winding interface will be displayed (as shown in the right figure)

③ Start Winding

Step the start pedal, and then the sewing machine runs and starts winding bottom thread.

④ Stop the sewing machine

Press STOP button  to stop the sewing machine. The system will return to the normal mode. By the way, in the bottom-thread winding mode, stepping the start pedal will stop the machine at this mode. Step the pedal again to resume winding. This function can be used at winding several shuttle cores.

Note: After user turns on the power, or changes to main controller input, the system will not perform the winding action. Please set the pattern and press the  to display the sewing interface.



2.7 Pattern Selection

① Enter Pattern Selection Interface

In the data input interface (as shown in right), click Sewing Shape (A) to enter the interface for selecting patterns.

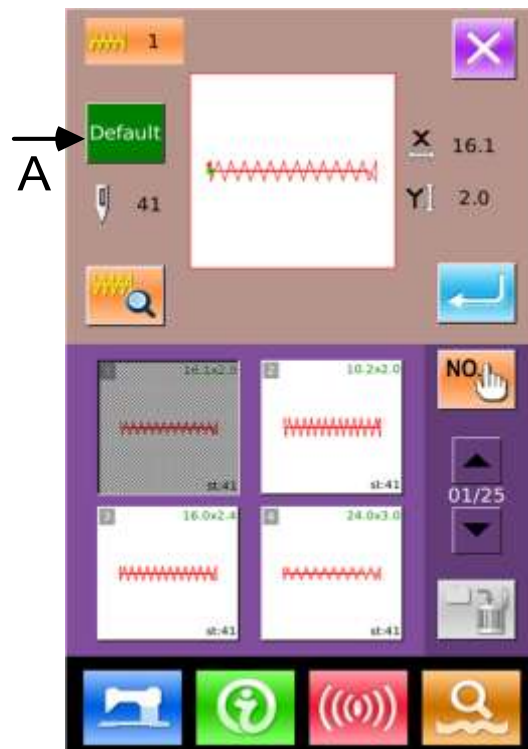
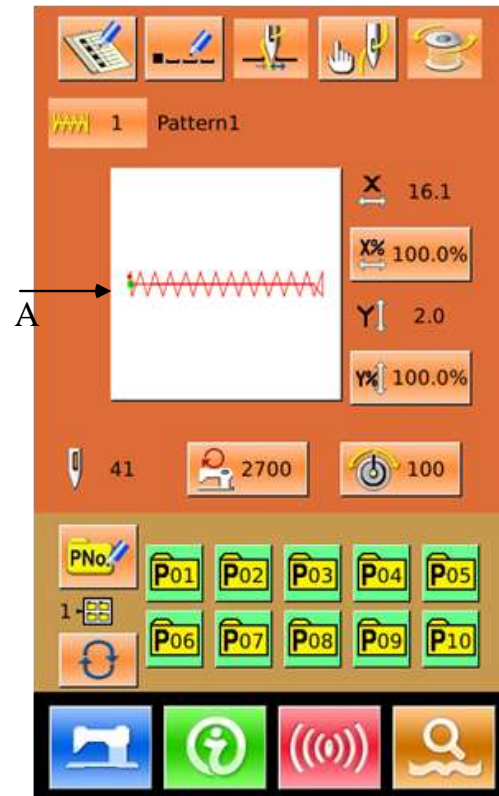

The upper area of the pattern selection interface is the sewing shape of the current pattern. Below that it is the number of the registered pattern.

 : Preview the pattern

 : Input the number to inquire pattern

: Delete the pattern

Click button A to shift between the basic patterns and user patterns, if the system has the normal patterns

② Pattern Selection

If the patterns are the basic patterns, 4 pattern numbers can be displayed in one page; for the user patterns, 20 pattern numbers can be displayed in one page. For the basic pattern, at each pattern number, the system will also display the shape and x/y range of the pattern. For the user patterns, only the pattern number will be displayed.

Select the registered pattern number. Then the system will display the content of that pattern in upper area. At this moment, press  to finish the selection.

③ Pattern Inquiry

Press  to activate the interface of Pattern Inquiry, input the number of pattern via the number keys.

④ Pattern Deletion

Select the registered pattern and then press , the pattern will be deleted. However, the patterns registered to P pattern can't be deleted.

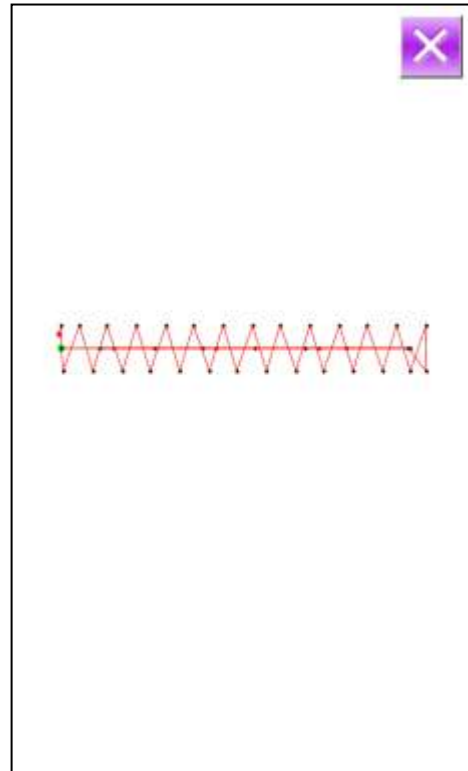

Note: Patterns are divided into basic pattern and normal pattern. The basic patterns are the default patterns, which can't be deleted. The normal patterns are the patterns made, copied or input by user, which can be deleted or modified.

⑤ **Pattern Preview**

Press  to preview the current pattern in full screen (White Background).

2.8 Sewing Data Setting

① **Enter Interface for Setting the Sewing Data**

In data input interface, pressing button A, B or C can enter the scale rate setting interface and speed limitation interface respectively.

	Item	Input Range	Default Value
A	X Scale Rate	1.0~400.0%	100.0%
B	Y Scale Rate	1.0~400.0%	100.0%
C	Max Speed	400~2700rpm (Different among different models)	2700rpm

Note 1: Parameter U64 can shift between the setting of scale rate and the setting of actual size.

Note 2: The range and the default value of Max speed are affected by the parameter U01.

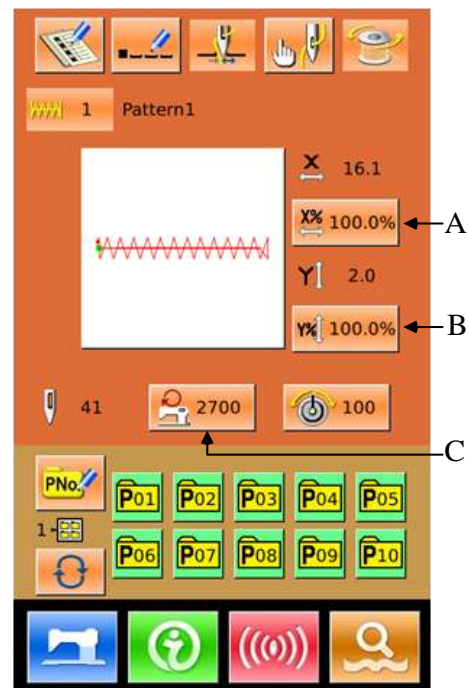

② Set Scale Rate

The right figure is the interface for setting the scale rate. The upper part is for setting X scale rate, while the lower part is for setting the Y scale rate.

A: X Actual Size

B: X Scale Rate

C: Y Actual Size

D: Y Scale Rate

Use **0** ~ **9** and number keyboard or **↑** & **↓** to input the value. The input value will be inserted to the first place of the figure. The number input at before will be moved forwards. Press **↵** to finish the operation and return to data input interface.。

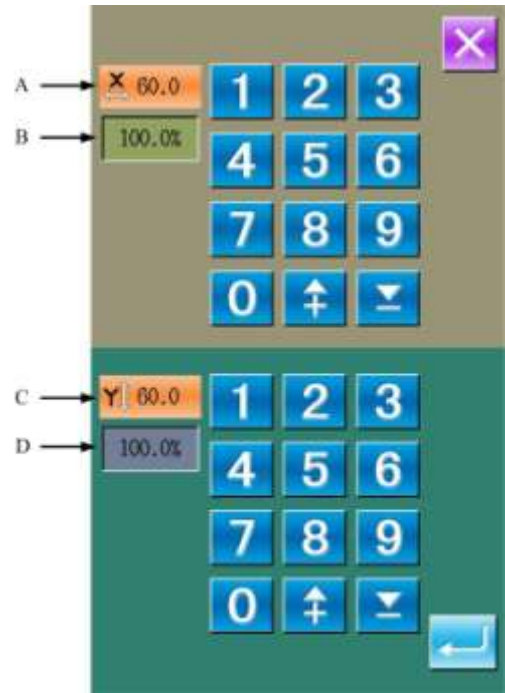

③ Set Max Speed

The operation is same to that in above.







2.9 P Pattern Registration

① Enter P Pattern Registration Interface

In data input interface, press  to enter the interface of P Pattern Registration (shown as the right figure)

② Input P Pattern Number

Use  ~  and number keyboard or  &  to input the number for registration. If the input number has been registered in the system before, the interface will display the shape and relating data of that registered pattern. In this situation, the new pattern can not be registered with this number



③ Select File Folder Number

P pattern number can be registered into 5 file folders, and each folder can contain 10 P patterns at most.

Press  to select folder in order.

④ Confirm Pattern Number

Press  to finish the Registration of P Pattern and return to the input interface of P Pattern Data







2.10 Trial Sewing

① Display the interface of sewing

At data input interface, press , the background of screen will change to blue, and the system enters the interface for sewing



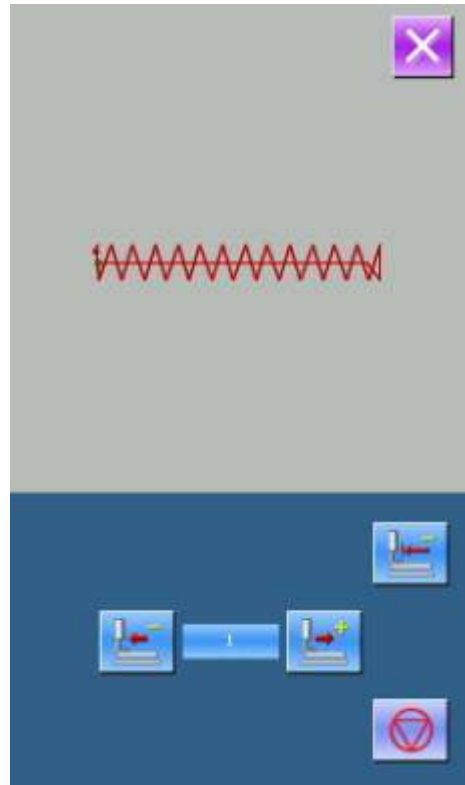

② Display of Trial Sewing

In the sewing interface. Press  to enter the trial sewing interface (As Shown at Right):



-  : Return to Origin
-  : Return
-  : Forward
-  : Stop



③ Start Trial Sewing



Step the pedal to lower the presser. Use  and  to confirm the shape. After user holds that button for a while and then release it, the presser will still keep moving. At this moment, please press  to stop it. Press  to have needle return to origin. And the system will return to the sewing interface.

④ End Trial Sewing

Press  to quit the trial sewing interface and return to sewing interface. When the pattern is not at the start position or end position, user can carry out sewing in the middle by stepping the pedal. For quit, please press  and turn off the activated interface. Then the sewing interface will displayed and the system returns to the sewing start position.

2.11 Counter Operation

③ Display the counter interface

In the sewing interface, press  (), the interface of counter setting comes out.



: Sewing Counter



: No. of Pieces Counter

④ Selection and Setting of Counter

The user can set the type of counter by choosing



and



, and set the value of counter



2.12 Emergency Stop

By setting parameter U31 to select pause method:

User can select among Invalidity, Panel and EXT to set the pause method.

When the pause button is pressed, the interface

will display the .

① Release the Error

Press Pause button at sewing to stop sewing machine. At this moment, the error interface is displayed, which hints user the pause key is

pressed. At this moment, press  to release the error.

② Trimming

Press  to cut thread and enter the procedure setting interface.

Note: When the Parameter U97 is set at Auto Trim at Pause, the system will enter procedure setting directly.

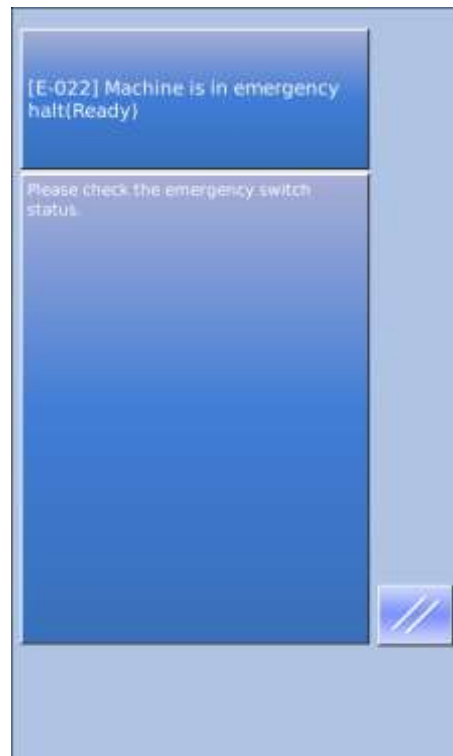



② **Set procedure and adjust the presser to re-sewing position**

Press  to enter procedure setting interface.

 : Backward feeding

 : Forward feeding

 : Return to Origin

Press  or  to move presser to the re-sewing position

③ **Restart sewing**

Step pedal to restart sewing

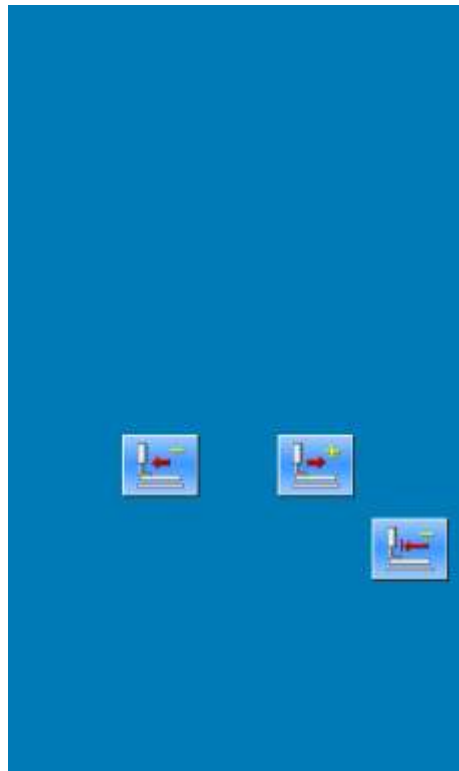

2.13 Setting of Thread Tension at Single Stitch

① Enter the interface for setting single stitch thread tension

In the running interface (as shown in right), click button A to enter the interface for setting the thread tension.

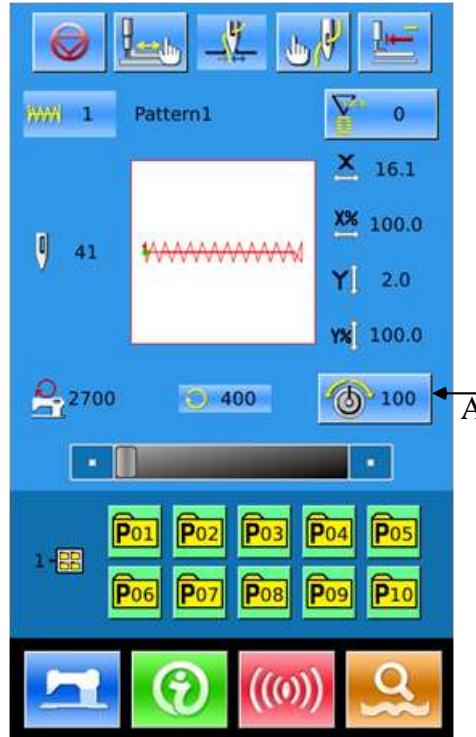

In the thread tension setting interface (as shown in right), click single stitch thread tension button (B) to enter the interface for setting single stitch thread tension.

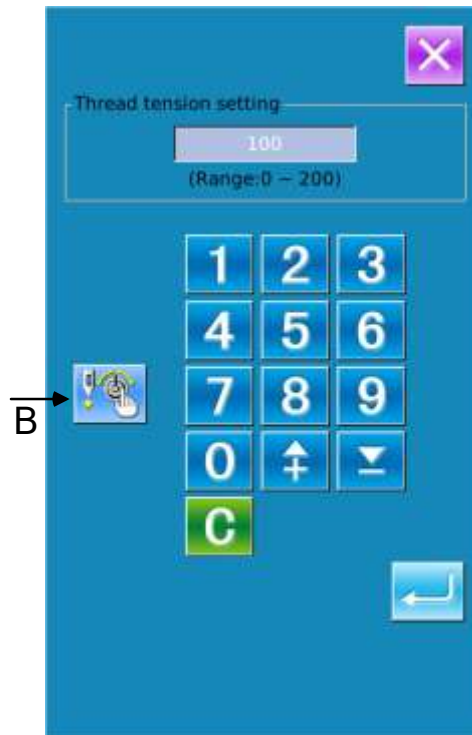

② Setting of Single Stitch Thread Tension

Click to enter the thread tension setting interface. The setting method is same to that in 2.5.

In the status of lowering the outer presser, use or to go forward or retreat for one stitch. Use or to move the needle entry point with thread tension order forwardly or backwardly. For stopping the machine, please press .

Press to return to origin.

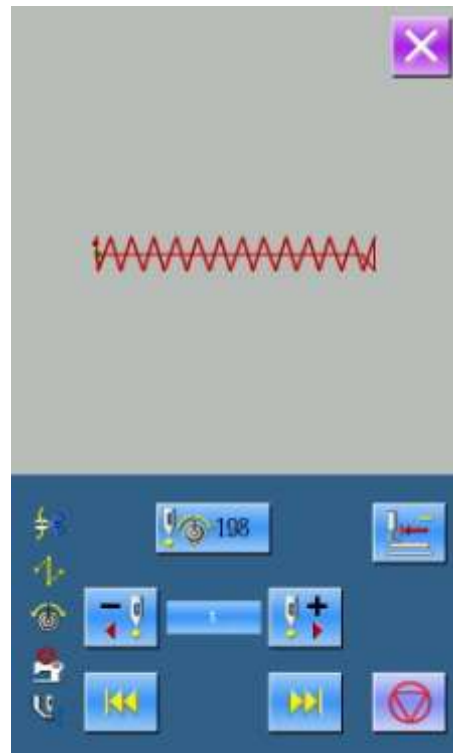

3 Operations on Prompt (P) Pattern

3.1 P Pattern Data Input

The Prompt pattern is called P Pattern for short, which contains a normal pattern and its relating sewing parameters, like X scale rate, Y scale rate, speed limitation and so on. If selecting a P pattern, user will get rid of the trouble for setting the parameters of the pattern at each time sewing

In the right picture, is shown the P Pattern Data Input Interface.

50 P patterns can be registered at most.

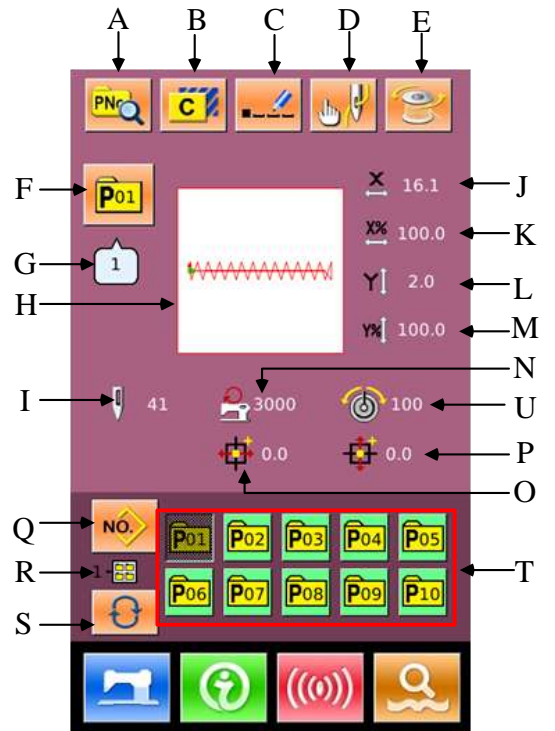

List of Function Keys:

No.	Functions	Content
A	P Pattern Edition	Edit the content of P pattern
B	P Pattern Copy	Copy the content of existing P pattern to an empty pattern number.
C	Pattern Naming	14 figures can be inputted at most.
D	Threading	Presser it to lower the presser.
E	Winding	Wind the thread with a press on 
F	P Pattern Number Display	Display the number of the selected pattern.
G	Sewing Shape Number Display	Display the number of the normal pattern quoted in the existing P pattern.

No.	Functions	Content
H	Sewing Shape Selection	Display the sewing shape of the current pattern
I	Pattern Stitch Number Display	Display the stitch number of the currently selected pattern.
J	X Actual Size Display	Display the X actual size of current pattern
K	X Scale Rate Setting	Display the X scale rate of current pattern
L	Y Actual Size Display	Display the Y actual size of current pattern
M	Y Scale Rate Setting	Display the Y scale rate of current pattern
N	Max Speed Limitation	Display the Max Speed
O	X Travel Amount Display	Display the X travel amount of the currently selected pattern
P	Y Travel Amount Display	Display the Y travel amount of the currently selected pattern
Q	Return to Normal Pattern Data Input	Return to the interface for inputting normal pattern data
R	P Pattern File Folder Display	Display the file folder number of the current P pattern
S	P Pattern File Folder Selection	Shift the file folder number of P pattern in sequence.
T	P Pattern Selection	Display the registered P pattern
U	Thread Tension Value	Display the basic value of thread tension of this pattern

3.2 P Pattern Edition

① Have Access to P Pattern Edition Interface

Press  to have access to P Pattern Edition Interface (as shown at the right picture)

② Change the Item Data

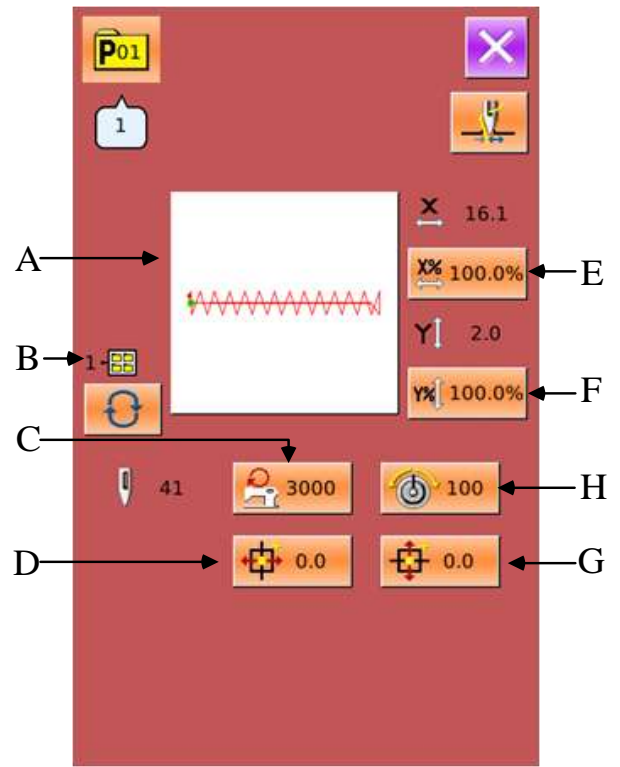

Select the item for changing and set the value.

	Item	Range	Default Value
A	Sewing Shape		
B	File Folder Number	1~5	
C	Max Speed Limitation	400~3000rpm	3000rpm
D	X Travel Amount	-30.0~30.0mm	0
E	X Scale Rate	1.0~400.0%	100.0%
F	Y Scale Rate	1.0~400.0%	100.0%
G	Y Travel Amount	-30.0~30.0mm	0
H	Thread Tension	0~200	100





③ Confirm the Change of Data

Take the edition of “X Travel Amount” as example:

With **0** ~ **9** and keyboard or  / ,

user can input the value. Press  to finish the operation.

- : The Positive Figure;
- : The Minus Figure.



④ Quit the Edition

Press  to close P Pattern Edition Interface and the system will return to the Interface for Inputting Sewing Data.



3.3 P Pattern Copy

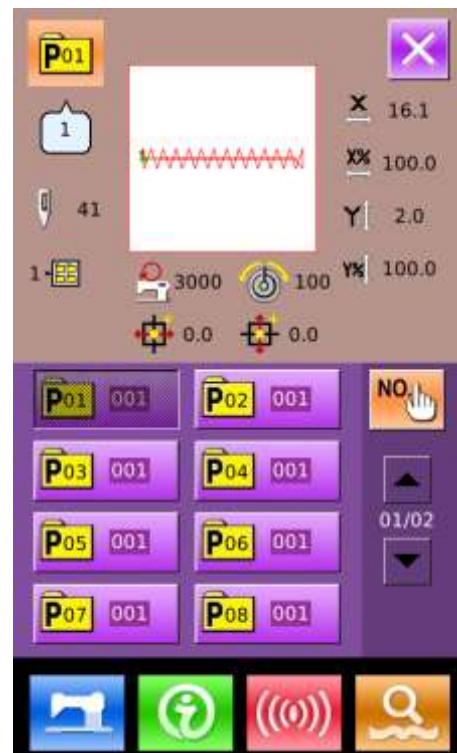

① Select a Pattern to Be Copied

Press  to have access to P Pattern Copy Interface (as shown at right picture). Select the number of the pattern that needs copying among the registered ones, and then press .



② Input newly Registered Pattern Number

The Pattern to be copied is displayed at the upper side of the interface. By using number keys, user can select the unregistered pattern number. The registered pattern number is unable to be registered again.

When pressing , user can select the file folder for saving. Press  to finish the operations for copying the pattern, and the system will return to the Interface for Copying P Pattern

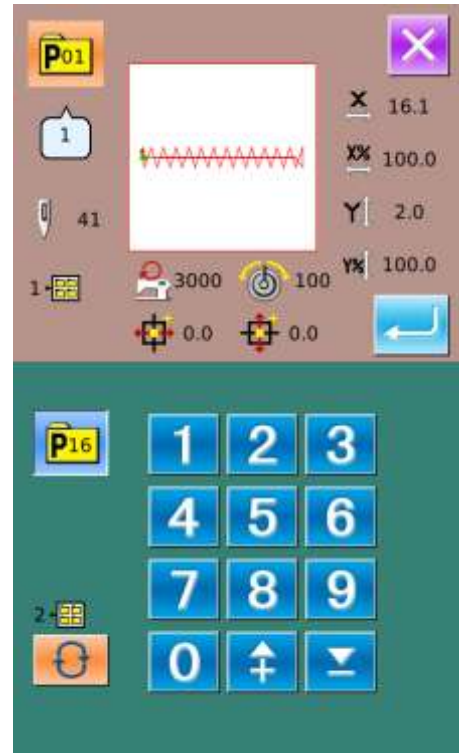

3.4 P Pattern Selection

① Have Access to P Pattern Selection Interface

As shown in right picture, user can press Key (A) to have access to P Pattern Selection Interface

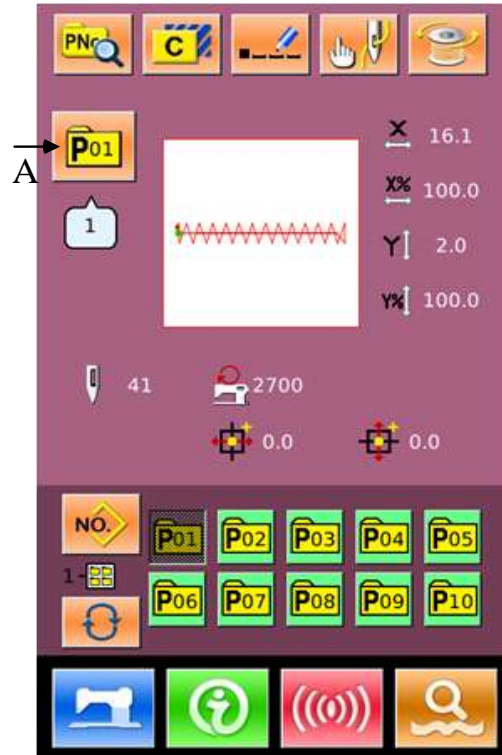

② Select Pattern Number

The relating information of the currently selected pattern is displayed at the upper side of the interface.

When user presses  to shift the status of concealing the file folder number, the entire registered P patterns can be displayed.

③ Confirm the Selection of Pattern

The operation is same to that of normal pattern selection. Press  to end the selection.

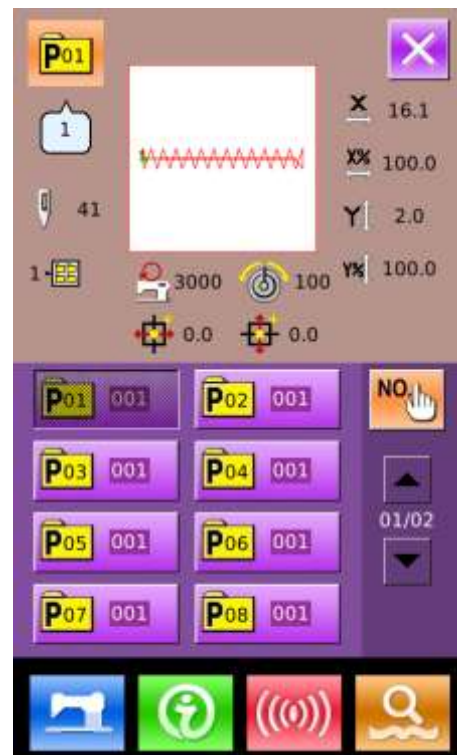

3.5 P Pattern Sewing

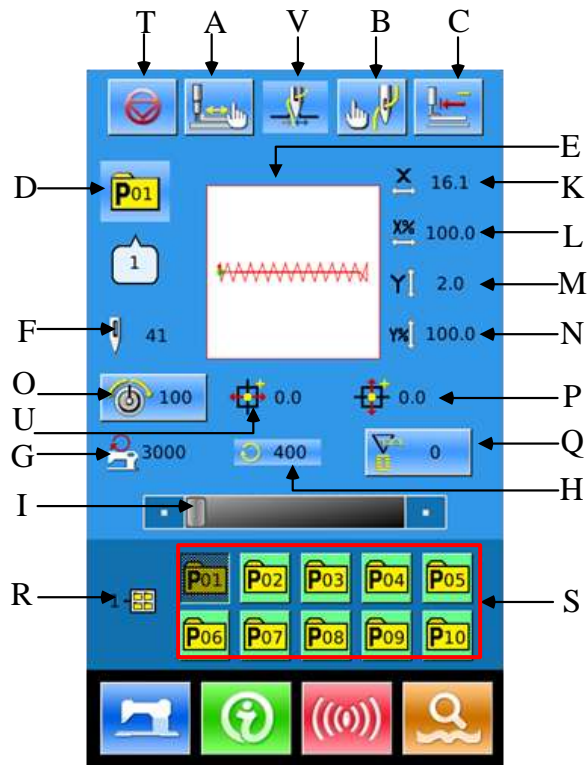

At the Interface for Inputting P Pattern

Data, User can press  to have access to the Sewing Interface (as shown in right).



List of Functions Keys:

No.	Functions	Content
A	Trial Sewing	Press it to have access to Trial Sewing Interface, where user can determine the shape of f pattern.
B	Threading	Press it to lower the presser.
C	Return to Origin	Press it to have the presser return to the start point.
D	P Pattern Number Display	Display the number of the currently selected pattern.
E	Sewing Shape Number Display	Display the number of the normal pattern quoted in the existing P pattern.
F	Pattern Stitch Number Display	Display the sewing stitch number of the currently selected pattern
G	Max Speed Limitation	Display the Max Speed Limitation
H	Sewing Speed Display	Display the current sewing speed

No.	Functions	Content
I	Sewing Speed Setting	Change the sewing speed
K	X Actual Size Display	Display the X actual size of current pattern
L	X Scale Rate Setting	Display the X scale rate of current pattern
M	Y Actual Size Display	Display the Y actual size of current pattern
N	Y Scale Rate Setting	Display the Y scale rate of current pattern
O	X Travel Amount Display	Display the X travel amount of the currently selected pattern
P	Y Travel Amount Display	Display the Y travel amount of the currently selected pattern
Q	Counter Setting	Press it to set the type and the present value of counter.  : Sewing Counter  : No. Pieces Counter
R	P Pattern File Folder Number Display	Display the file folder number of the current P pattern
S	P Pattern Selection	Display the registered P pattern
T	Pause	Press it to stop machine. It is controlled by parameter U31. When user selects Panel at that parameter, the screen will display the pause key. Other options will not display that button on screen.
U	Thread Tension Setting	Press it to enter the interface for setting thread tension.
V	Thread-catching	Select the effective/ ineffective of thread-catching function. It is affected by parameter U35.

4 Operations on Combination (C) Pattern

4.1 C Pattern Data Input

The combination pattern, called as C pattern for short, consists of a group of P patterns, which can contain 50 sub-patterns at most. In this model, 50 C patterns can be registered into the system at most.

For having access to the Interface of Combination Pattern Data Input (as shown at right), please refer the content in [8.8 Change Sewing Type]

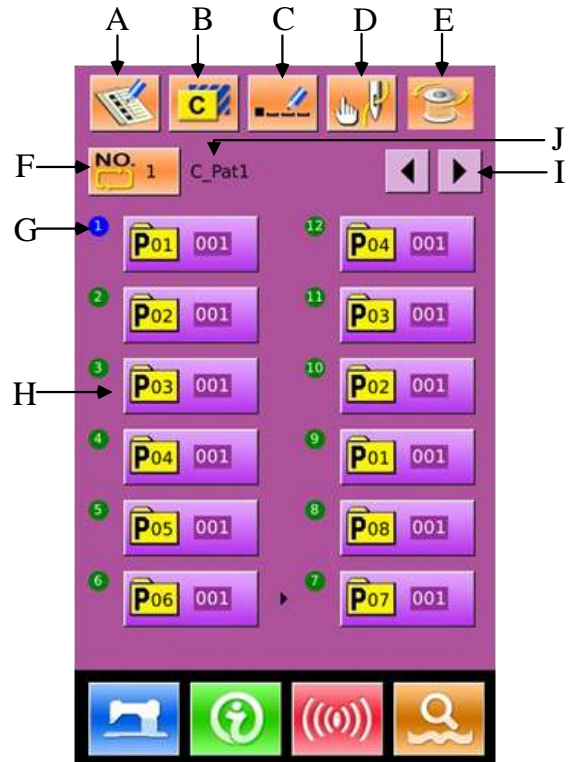

List of Function Keys:

No.	Function	Contents
A	C Pattern Registration	Register a new C pattern.
B	C Pattern Copy	Copy the content of Current C pattern to an empty pattern number.
C	Pattern Naming	14 figures can be inputted at most.
D	Threading	Press it to lower the presser.
E	Winding	Wind the thread with a press on  .
F	C Pattern Number Selection	The number of the currently selected pattern is displayed on the button. Press it to have access to the C Pattern Selection Interface.

No.	Function	Contents
G	Sewing Sequence Display	Display the sewing sequence of the currently selected pattern. The pattern with a blue marks is the initial sewing pattern.
H	C Pattern Shape Selection	Press it to have access to C Pattern Edition Interface. Operator can select a P pattern to input.
I	Page	30 C patterns can be registered at most, and 6 C patterns can be displayed on each page at most.
J	C Pattern Name	Display the Name of C pattern.

4.2 C Pattern Edition

① Have Access to C Pattern Edition Interface

At Interface of C Pattern Data Input, user can press A to have access to C Pattern Edition Interface.

In initial status, because no sewing shape is registered to P pattern, the first one is displayed as blank.

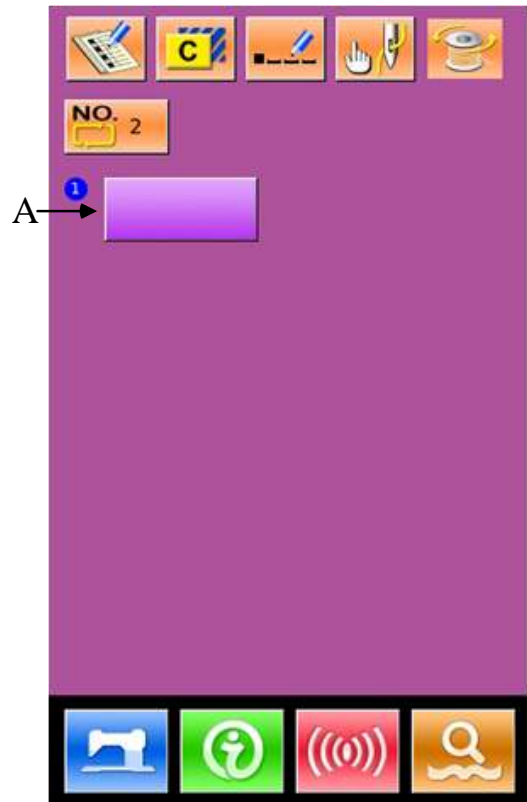

② Select Shape

At C Pattern Edition Interface (the right figure), user can select the P Pattern (B) for registration

and then press  to finish the selection.

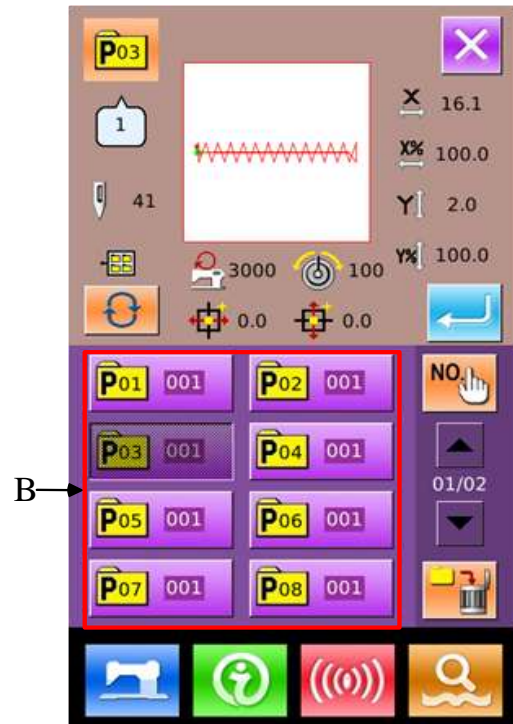

③ Repeat the Registration

When the 1st pattern is registered, the Selection Key (C) for the 2nd pattern is displayed. Repeat the operations at above so as to register other patterns.

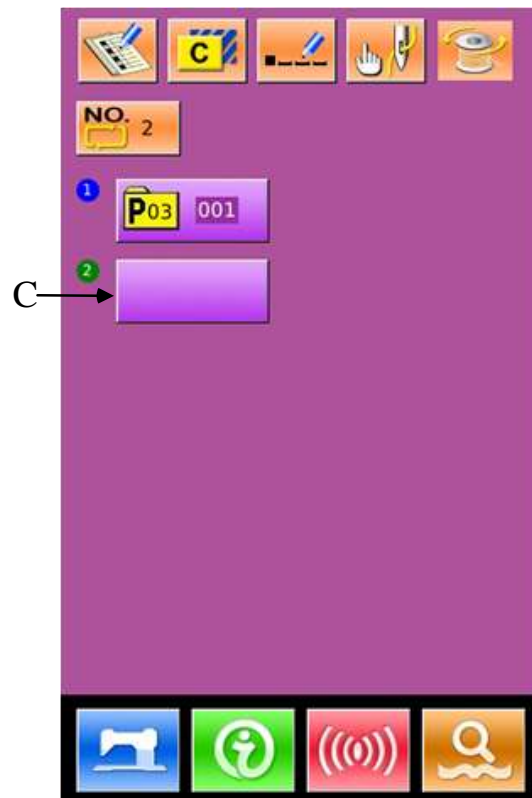

4.3 C Pattern Selection

① Have Access to C Pattern Selection Interface

As shown on the right picture, user can have access to C Pattern Selection Interface by pressing Figure A.

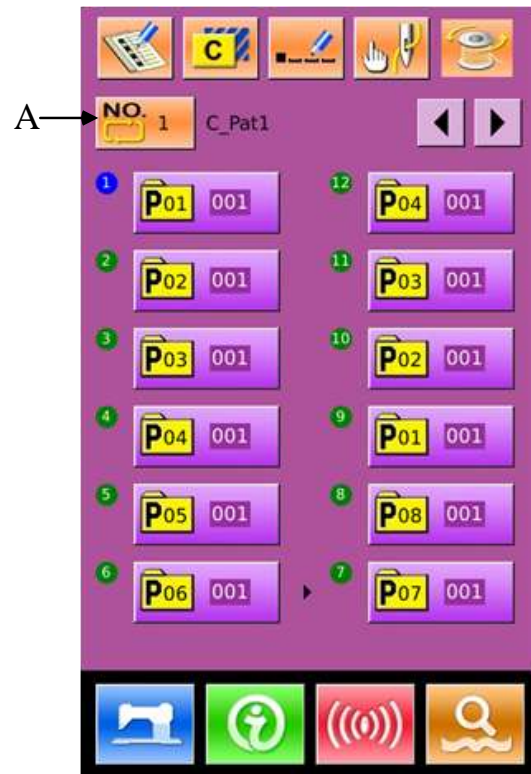

② Select C Pattern Number

At C Pattern Selection Interface (the right figure), user can press B to change the data information of P patterns within the current C pattern in sequence.

Confirm the number of the needed C pattern

(C), and then press  to finish selection

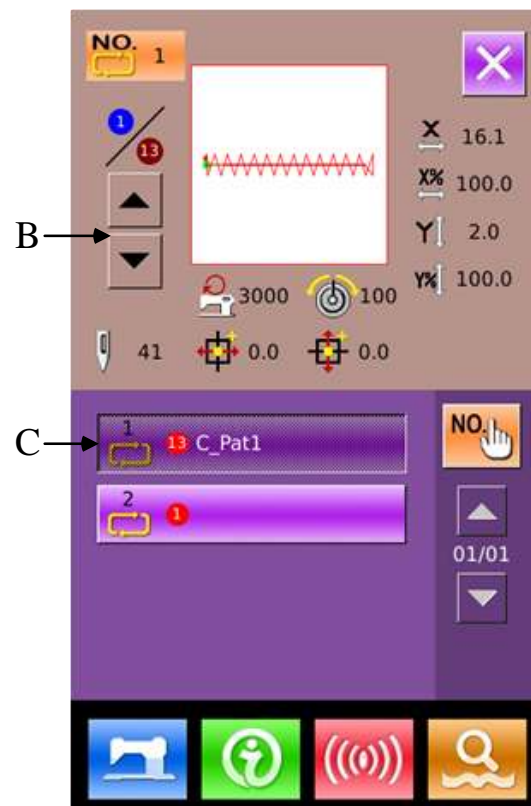

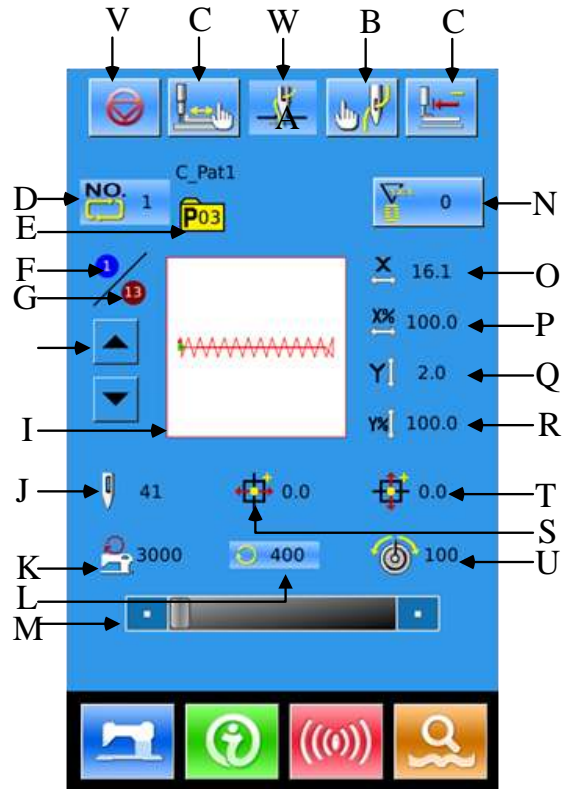

4.4 C Pattern Sewing

At Interface of C Pattern Data Input, user can press  to have access to Sewing Interface (as shown in right picture).



List of Function Keys:

No.	Functions	Contents
A	Trial Sewing	Press it to have access to Trial Sewing Interface, where user can determine the shape of f pattern.
B	Threading	Press it to lower the presser.
C	Return to Origin	Press it to have the presser return to the start point.
D	C Pattern Number	Display number of current C pattern
E	Sewing Shape Number Display	Display the number of the sewing shape registered under the current C pattern
F	Sewing Sequence Display	Display the sewing sequence number at current pattern
G	Total Number Display	Display the total number of sub-patterns registered in the current C pattern

No.	Functions	Contents
H	Sewing Sequence Forward/Backward	Select the previous or next shape for sewing.
I	Pattern Shape	Display the shape registered at current sewing
J	Patten Stitch Number Display	Display the stitch number of the shape registered at current C pattern.
K	Max Speed Limitation Display	Display the Max speed at sewing this shape
L	Sewing Speed Display	Display current sewing speed
M	Sewing Speed Setting	Enable to change sewing speed
N	Counter Setting	Press it to set the type and the present value of counter.  : Sewing Counter  : No. Pieces Counter
O	X Actual Size Display	Display the actual size of the selected pattern in X direction.
P	X Scale Rate Setting	Display the X scale rate of the selected pattern.
Q	Y Actual Size Display	Display the actual size of the selected pattern in Y direction.
R	Y Scale Rate Setting	Display the Y scale rate of the selected pattern.
S	X Travel Amount Display	Display the X travel amount of the currently selected pattern
T	Y Travel Amount Display	Display the Y travel amount of the currently selected pattern
U	Thread Tension	Display the basic value of thread tension
V	Pause	Press it to stop machine. It is affected by Parameter U31. Select "Panel" to display the pause button on screen. Other options will not

No.	Functions	Contents
		display the figure on screen.
W	Thread-catching	Select the validity and invalidity of thread-catching function. It is affected by parameter U35.

5 Pattern Edition

5.1 Have Access to Pattern Edition Mode

User can press  to shift the data input interface to the Mode Selection Interface (as shown at right picture), where user can make some detailed settings and editions.



For the detailed operations and settings at Mode Selection Interface, please refer to【8 Mode and Parameter Setting】.



Press  to shift with .

 : Sewing Mode

 : Edition Mode







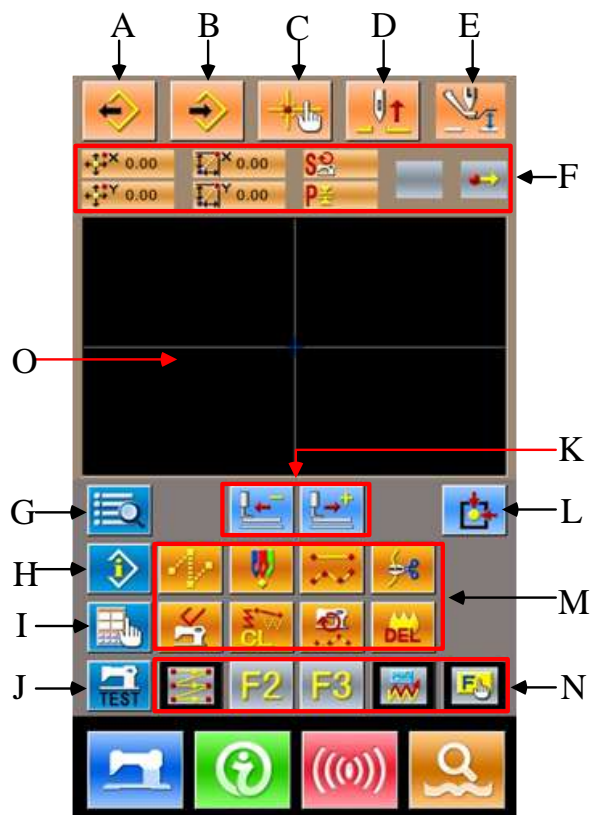

Select , and then press  again to quit the Mode Selection Interface. At this moment, the system will ask user whether to have access to Pattern Edition Interface.





Press  to have access to Standard Interface for Pattern Edition, as shown in the right picture:









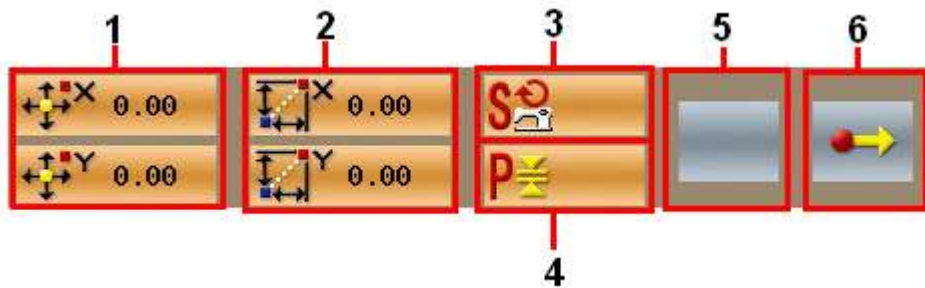

List of Function Keys:

No.	Function	Contents
A	Load Pattern	Display the Pattern Loading Interface
B	Input Pattern	Display the Pattern Input Interface
C	Needle-entry Point Inquiry	Promptly locate the needle entry point; when editing the patterns, user can input the coordinates of the sewing point directly.
D	Lift needle	Make needle return to the highest point
E	Move Intermediate Presser	Lift or lower the intermediate presser
F	Current Needle Position Information	Display the position information of needle at present
G	Code List	Display the entire available editing functions. Please refer to [List of Editing Functions] for details.
H	Information Display	Display the detailed information of the currently edited pattern
I	Display Setting	Enable wide-angle setting, needle entry point display setting and so on
J	Trial Sewing	Sew the currently edited pattern through a trial sewing
K	Forward ·Backward Feeding	Move one stitch from the current position (forwards  ; backwards )
L	Return to Origin	Return the needle from current position to origin
M	Function Keys	Call the functions on the buttons directly
		 1 : Empty feeding
		 2 : Point Sewing
		 3 : Normal Sewing
		 4 : Thread-trimming
		 5 : Cancellation of Mechanical Control Order
 6 : Element Deletion		

No.	Function	Contents
		 7 : Changes on Sewing Speed Section  8 : Delete Current Pattern
N	Hot Keys	By using Function of Selection and Setting (Function Code 112), user can distribute the needed functions to each button. After the distribution, the figure of that function is displayed in the corresponding key.
O	Pattern Shape Display Area	Display the pattern



No.	Item	Content
1	Absolute Coordinate	The absolute coordinate of current needle position to the origin
2	Relating Coordinate	The relating coordinate of current needle position
3	Speed	The sewing speed or empty feeding speed of current point.
4	Interval	The length of current element stitch. (If the stitch is scaled, the value before the scaling will be displayed.)
5	Type of Element	Types of current elements. At setting sewing data, the system will displayed the element types, like jump feed  , broken line  , free curve  and so on). At setting the mechanical orders, the type of the control order will be displayed (like thread-trimming).
6	Types of Needle Entry	The types of the needle entry position:  Start of Design: the start point (Origin) of a design.

No.	Item	Content
		 Middle Point of Element: the middle point of the element (neither the top point nor the ending point of the element).
		 Top Point: the top point of a broken line.
		 End Point of Element: the ending point of the element
		 End Point of Pattern: the ending of pattern.

5.2 Pattern Edition

Use Function of Pattern Edition to input the following pattern.

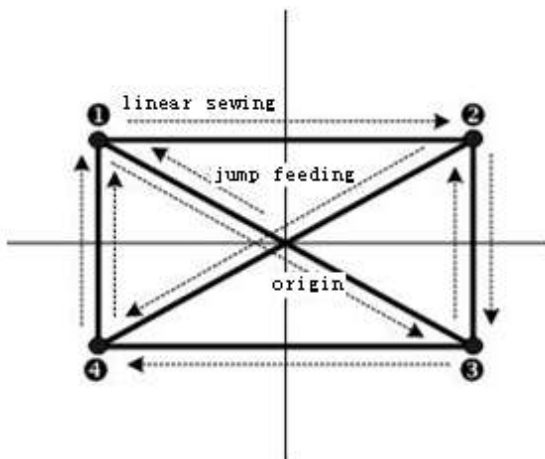

Input Point:

	X (mm)	Y (mm)
①	-40.00	25.00
②	40.00	25.00
③	40.00	-25.00
④	-40.00	-25.00

Input Order: It is shown as the dotted arrow in the left.

① Input of Empty Feeding

At Standard Interface for Pattern Edition,



user can press  to activate the Interface for Setting Empty Feeding::

Note: user can also select “020: Empty Feeding” from function code list to enter the interface



After user presses , the Interface for Locating the Empty Feeding Position will be displayed:

At that Interface, user can use Direction Key (A) to move the icon (needle position) to the position with coordinate (0, 10). After

pressing  for confirmation, user need press  to save the settings. After that,

the system will return to the Standard Interface for Pattern Edition and display the empty Feeding stitch

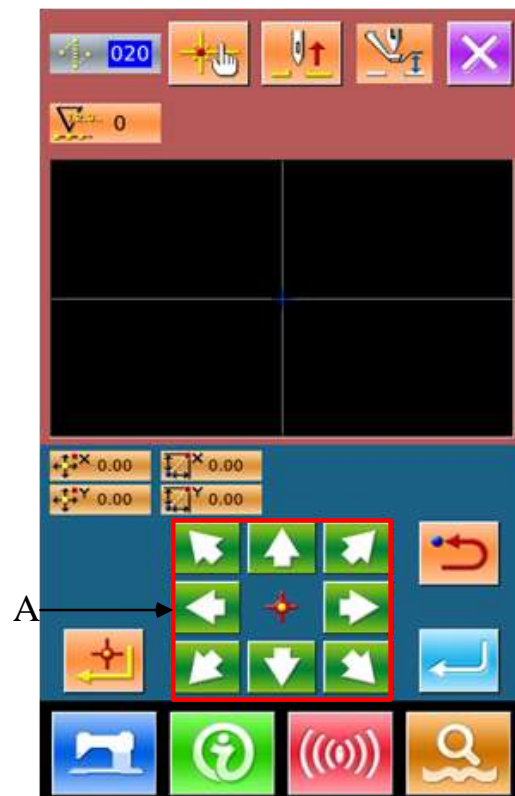

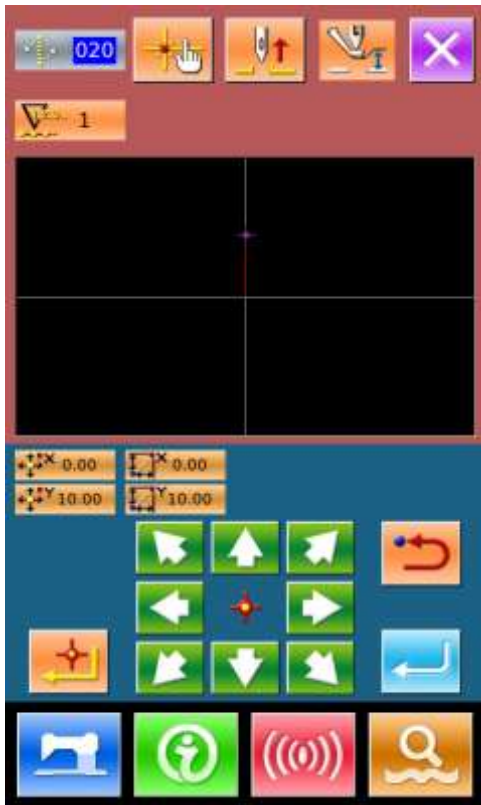



② Input of Linear Normal Sewing

At Function Code List, select “023 Linear Normal Sewing”, and then press  to have access to Interface for Setting Linear Normal Sewing



At Interface for Setting Linear Normal

Sewing, press  to have access to the interface for setting the sewing stitch length, as shown in right picture.

Press  and  in order to change the sewing length to “3.0”, and then press “ENTER” to save value and have the system return to the Interface for Setting Linear Normal Sewing



Note: Press  to clear the value.

After confirming the value “3.0mm” as the length of sewing stitch, user can press  to have access to the Interface for Setting Linear Normal Sewing.

In that interface, user needs press Direction Keys to move the icon (where the needle

locates) from **1** to **2**, and then press .

Repeat the above operations to move the icon in the order

of **2** → **3** → **4** → **1** → **3** → **2** → **4** → **1**

, as shown in right picture.

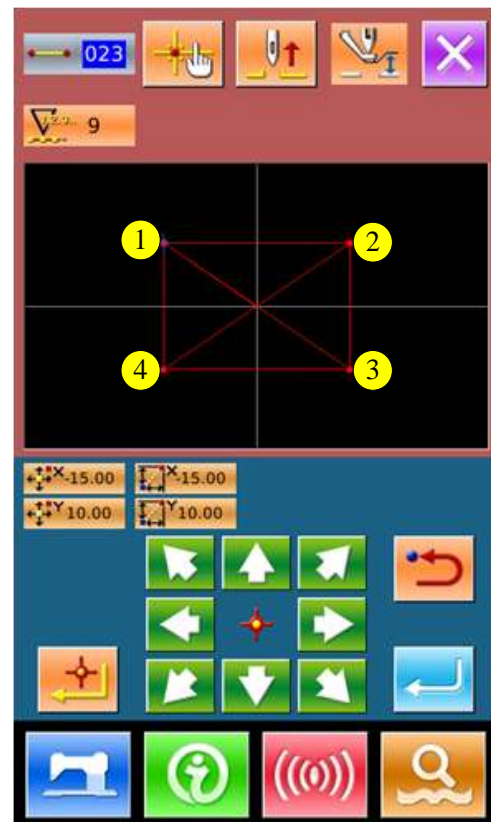

After confirming the pattern design, user can p



to create the pattern data and have syst
return to Standard Interface for Pattern Edition
where the pattern will be displayed.

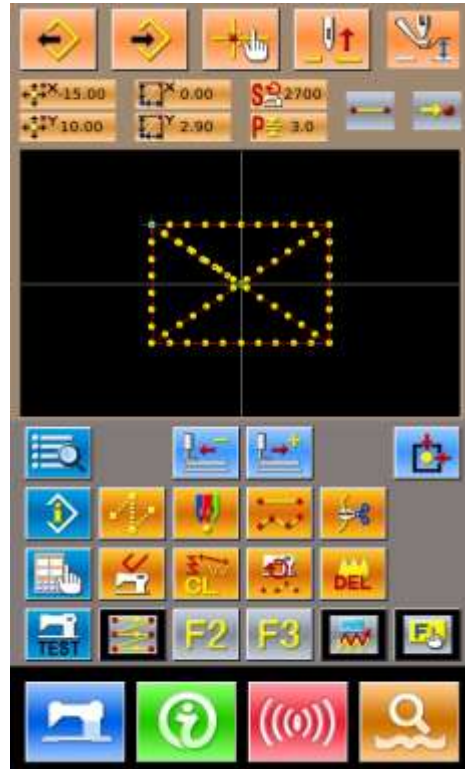



③ Save Pattern

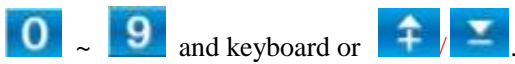

Press to have access to Pattern Saving
Interface to save the edited pattern, as shown in
right pictures.

The system will set the pattern number
automatically; user can also input the value with



With  and , user can select the
location for saving the pattern. Both the U disk
and the memory on operation panel will be
available for saving the pattern.



Press  to save pattern. Then the system will ask user whether to insert thread-trimming automatically, as shown at right picture.

Press  to add automatic thread-trimming action;

Press  to cancel the insertion of automatic thread-trimming action

After the operations, the system will return to Standard Interface for Pattern Edition.

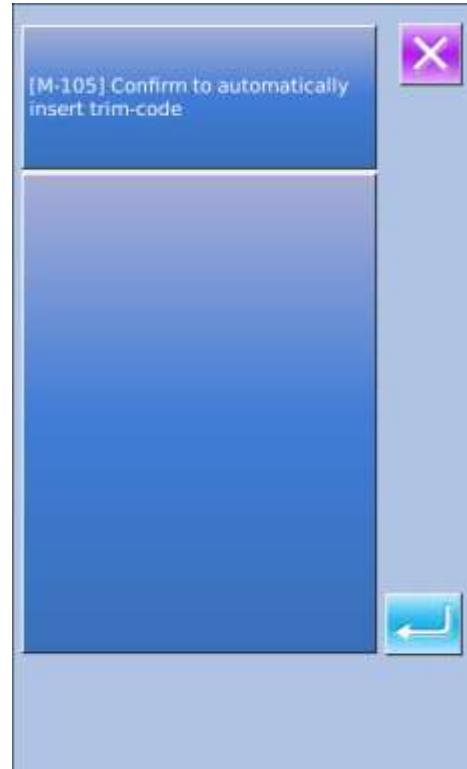

For the detailed operations and instructions of pattern edition, please refer to <SP510 Pattern-making Operation Manual>.

5.3 Quit Pattern Edition Mode

At Standard Interface for Pattern Edition, user can press  to have access to Mode Selection Interface, as shown at right picture.



Press  to shift to  :

 : Edition Mode

 : Sewing Mode

Press  again to quit the Mode Selection Interface. At this moment, the system will ask user whether to return to Sewing Mode.

Pressing  is to quit from Pattern Edition Mode and to head for Sewing Mode.



6 Information Functions

The Information Functions contain the following three functions:

- 1) The oil replacement (grease-up) time, needle replacement time, cleaning time, etc. can be specified and the warning notice can be performed after the lapse of the specified time.
- 2) Speed can be checked at a glance and the target achieving consciousness as a line or group is increased as well by the function to display the target output and the actual output.
- 3) Display the threading picture

6.1 Maintenance & Repair Information

① Display Information Interface

At Sewing Data Input Interface, user can Press Information Key (A) to activate the Information Interface.

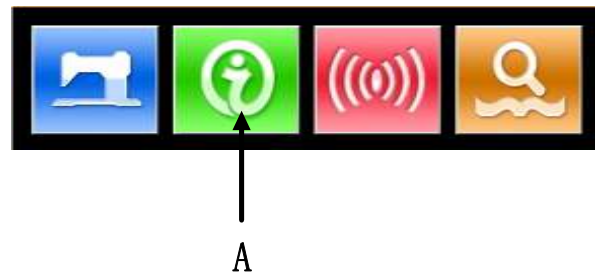

② Display Maintenance & Repair Interface

Please press  (B) at Information Interface

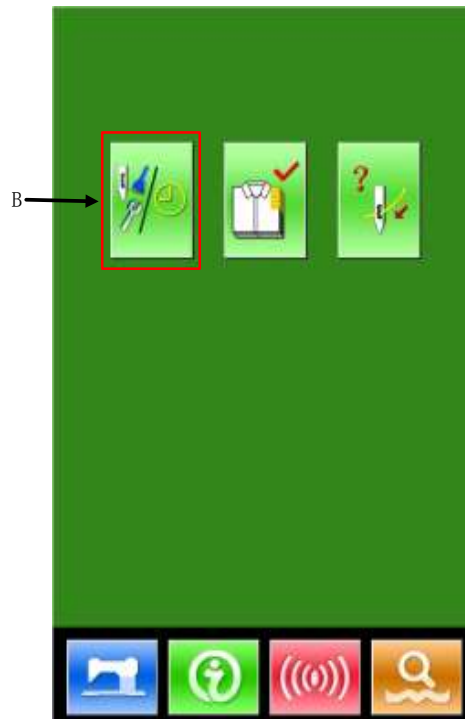

At Maintenance & Repair Interface, the system will display the information of the following three items



: Needle Replacement (Thousand

Stitches)\



: Cleaning Time (Hour)



: Oil Replacement Time (Hour)

The figure of each item is displayed on the button (C), the time interval for the repair notice is displayed at (D), and the time left to the replacement is displayed at (E)

Additionally, the time left to the replacement can be cleared by users.



Press to quit to information interface.

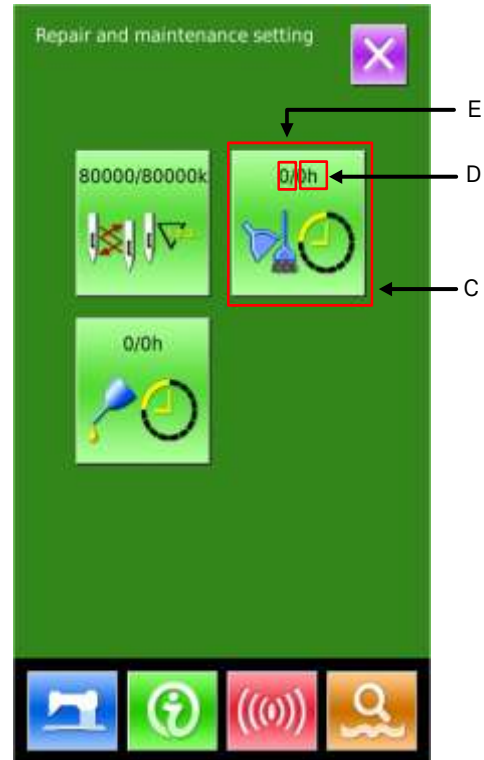

6. 2 Input Time for Maintenance & Repair

⑥ Display Information Interface (Maintenance Level)

At Interface for Inputting Sewing Data, user can hold the Information Key (A) for about 3 seconds to activate the Information Interface (Maintenance Level).

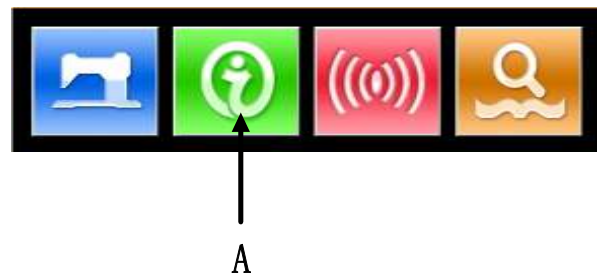

At that level, there are 6 buttons displayed on the interface

⑦ Information Interface

At Maintenance level, there are 6 functions displayed as below:

-  : Maintenance & Repair
-  : Production Control
-  : Threading
-  : Alarm Record
-  : Running Records
-  : Periodical Password

Please press Maintenance & Repair Information

Key  (B) to activate the interface.

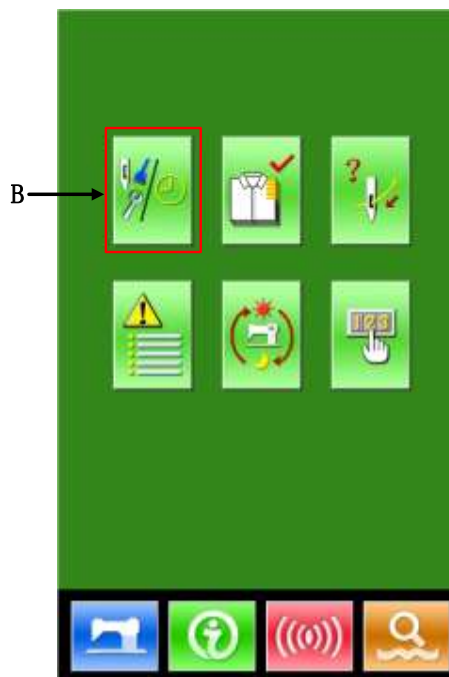

⑧ Setting of Maintenance & Repair

At Maintenance & Repair Information Interface, the information displayed is as same as that on the ordinary Maintenance & Repair Information Interface. Press the Item Button C (for changing the repair and maintenance time) to activate the relating input interface.

Exp. Pressing  is to set the cleaning time

Press  to return to the information interface directly

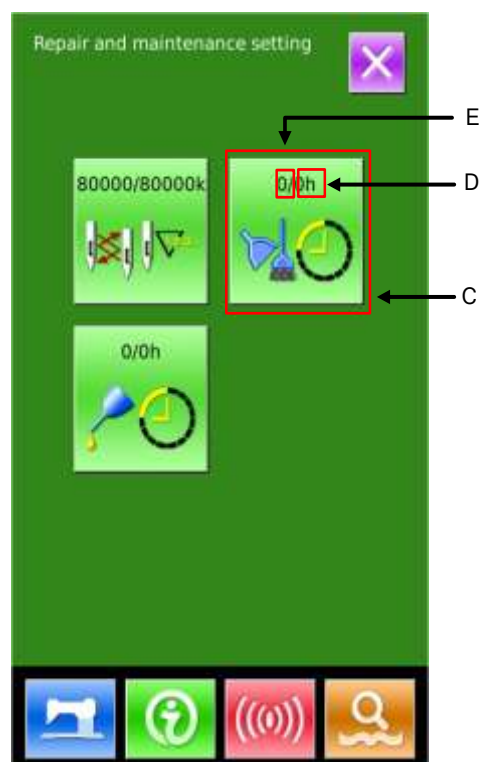

⑨ Set Maintenance & Repair Item

If the value of this item is set at 0, the function of maintenance & repair will be stopped.

The items for setting include:

- ◆ Needle Replacement Time
- ◆ Cleaning Time
- ◆ Oil Replacement Time

Press the figure to enter the corresponding interface:

A、 Input the value via keyboard

B、 Press  to confirm the input.

C、 Press  to return to the interface for repair & maintenance directly



6.3 How to Release Alarm

When it comes to the pointed time for maintenance or repair, the system will activate the prompt interface. If user wants to clear the maintenance and repair time, please press . Before the clearance of the maintenance and repair time, the information prompt interface will be displayed after each one sewing task.

The following are the prompt code for each item

- Needle Replacement : M-052
- Oil Replacement Time: M-053
- Cleaning Time: M-054

6.4 Production Control

In the interface of production control, the system will be able to display the amount of products from the beginning to now and the target producing amount, as long as the user fixes the time of start.

There are two ways to activate the production control interface:

- Via Information Interface
- Via Sewing Interface

6. 4. 1 Via Information Interface

① Display the Information Interface

At Interface for Inputting Sewing Data, press Information Key (A) to activate the Information Interface.

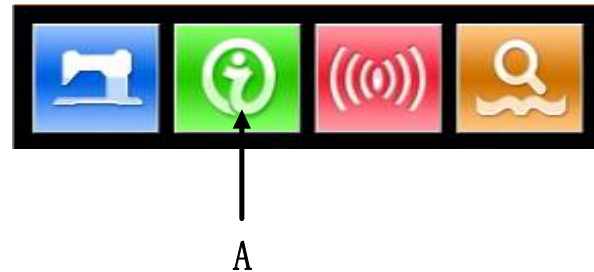

② Display the Production Control Interface

Please press Production Control Button (B) at the Information Interface so as to display the Production control interface (as shown at right picture) .



There are five items displayed on the production control interface

A: Existing Target Value

According to the pitch time, the target sewing amount up to now is displayed automatically.

B: Actual Result Value

Automatically display the amount of pieces sewn

C: Final Target Value

Set the final Target amount of production

D: Pitch Time of Target

Set the pitch time (Second) among each working process

E: Unit Interval of Actual

Set the actual time for finishing one process

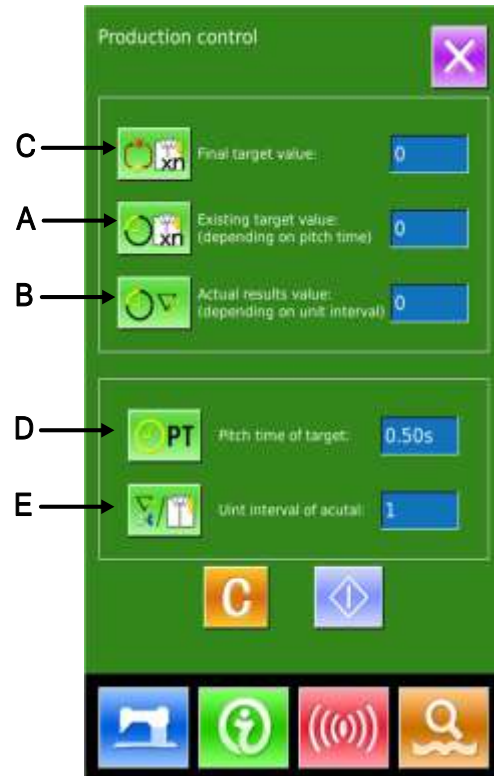

6. 4. 2 Via Sewing Interface

① **Display Sewing Interface**

At Interface for Inputting Sewing

Data, user can press  to activate the Sewing Interface.

② **Display Production Control Interface**

At Sewing Interface, user can press Information Key (A) to activate the Production Control Interface.

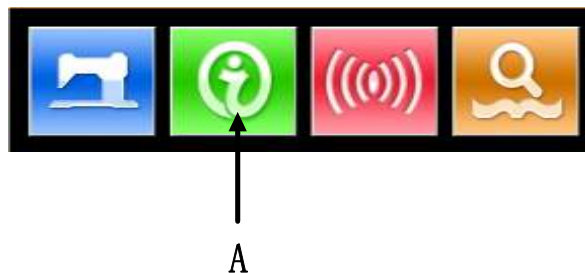

The displayed content and the functions are same to the content in Chapter 6.4.1 at above.

6. 4. 3 Setting on Production Control

① Display Production Control Interface

Press  to display the Production Control Interface

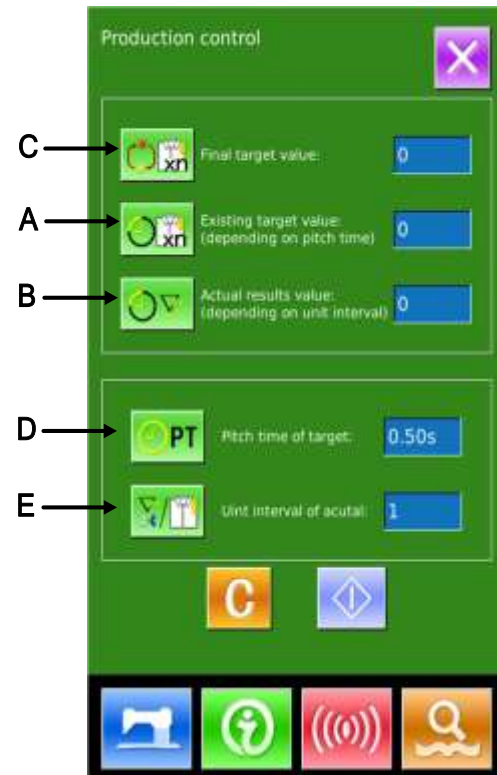



② Input Final Target Value

Firstly, please input the number of production target pieces to which the sewing is performed from now on. Press Final Target Amount Key



(C) to activate the Target Value Input Interface.



Please use the number keys or +/- keys to input the wished value. After the input, please press  to confirm. Press  to quit.

③ Input Pitch Time of Target

Then, input the pitch time needed for one process. By pressing the Pitch Time of Target



Key (D), user can activate the Pitch Time Input Interface.



Please use the number keys or +/- keys to input the wished value. After the input, please press  to confirm. Press  to quit.



⑩ Input Unit Interval of Actual

Then, input the time for trimming at one process in average. By pressing Unit Interval

of Actual Key  (E) at previous page, the user can activate the Interface for Inputting Trimming Time

Please use the number keys or +/- keys to input the wished value. After the input, please press  to confirm. Press  to quit.



⑤ Start to Count Amount of Production

Press  (I) to start counting the number of production amount, the [Final Target Amount], [Target Amount at Present] and [Actual Amount] will turns to dark





Final Target Value: Can be used as the time reference

Existing Target Value: The target value adds 1 after each time pitch set [Pitch Time of Target]

Actual Result Value: After entry from the “6.4.2 Via Sewing Interface”, the system will start count the actual value by adding 1 at finishing each piece

By setting the Target Value and the Actual Result Value, user can find out the change of productivity.

⑥ Stop Counting

In the status of counting, you can see the  displayed on the screen. Press  to stop counting. After stop, the Counting Key  will take the position of . If user wants to continue counting, please press .



Without pressing , the value will be kept.

Press  to quit directly

⑦ Clear the Data in Counter

For clearing the value of the counter, the user should stop the counter at first and then press .

The values of  and 

can be cleared both.

(Note: the clear key can only be displayed when the counter is stopped.)

After pressing , the Interface for Confirming Clearance is activated.

In the Interface for Confirming Clearance,

user can press  to confirm the

clearance. Press  to quit.



6. 5 Display Threading Figure

At Information Interface, user can press

Threading Button  (C) to activate the Threading Figure, which can be taken reference when user threads the machine.

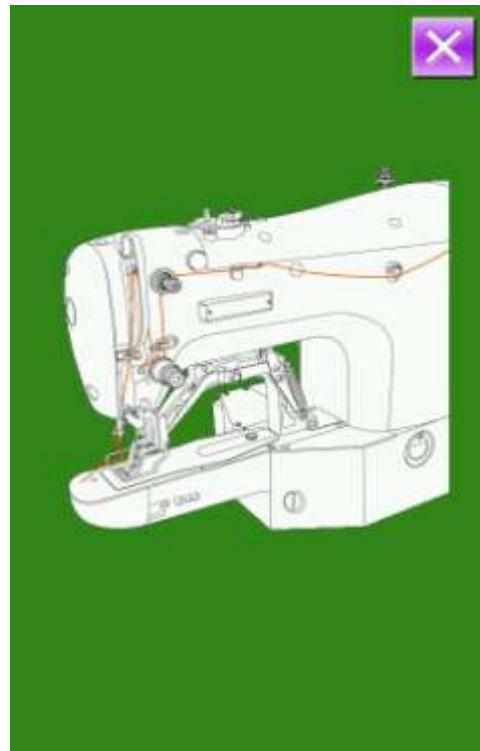
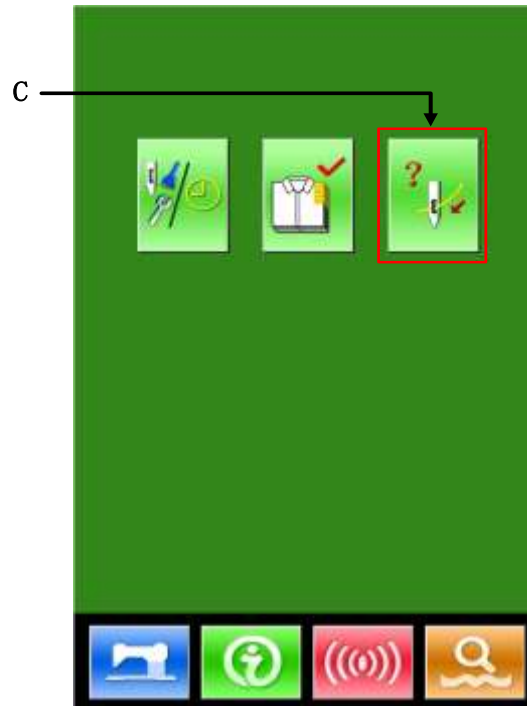

6. 6 Alarm Record

- ④ At Maintenance Level, press  to inquire the alarm records.



- ⑤ Press  to check the records

As in the picture, the warning information and the times of occurrence are displayed

Function of Keys:

A、 Press  or  to turn pages

B、 Press  to quit the inquiry

C、 Press  to clear the filed record



- ⑥ Press the number key at the left of the column to display the details of the warning records

Press  to quit



6.7 Running Record

- ③ In the interface of maintenance level, press



to check the running information of the machine



④ **The Running Records contain:**

- a) :Accumulated running time (Hour)
- b) :Accumulated times for thread trimming
- c) :Accumulated time of power-on (Hour)
- d) :Accumulated number of stitch (1000stitch)

A、 Press  to quit

B、 Press Clear to clear the record



6.8 Setting of Periodical Password

12) In maintenance level, Press  to set periodical password

In this interface, the system will ask user to input the User ID. Input the right manufacturer ID to enter the password management mode, where user can set and manage the periodical passwords.

- ◆ At most ten periodical passwords with different activation dates can be set
- ◆ The system will display the information of passwords set by manufacturer.



13) Press  To input User ID

Input User ID

1	2	3	4	5	6
7	8	9	0	A	B
C	D	E	F	G	H
I	J	K	L	M	N
O	P	Q	R	S	T
U	V	W	X	Y	Z





Factory

No.



14) Input the Correct Factory ID to enter the password setting interface

Procedure for setting the periodical password:

- A、Continue inputting other periodical passwords

15) Input Board Number

Press **【Board Number】** to enter the board number input interface. Input the board number and press  to finish the input

※ The board is a four-figure number, from 0~9999

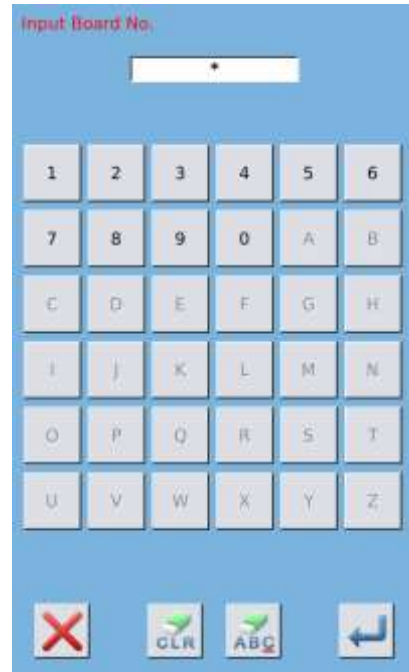

16) Input System Clock

Press **【Clock】** to enter the interface for setting the system clock. And set the time.



17) Input the super password

Press the 【 Super Password 】 to enter the interface for setting super password

- ※ At most, nine super passwords can be input
- ※ At the password confirmation, make sure the two input passwords are same

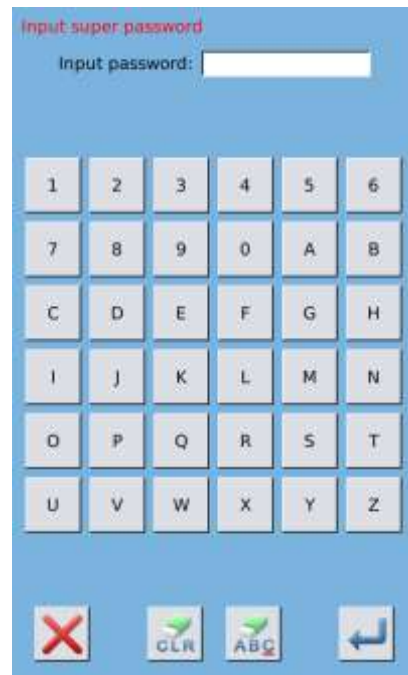
**18) Input periodical password**

Press 【 Password-1 】 to enter the first password date, where user can input the first date for activation. After selecting the proper date, user can press  for confirmation. Then enter the password setting interface to input the password.

- ※ The date should not be earlier than the system date
- ※ At the password confirmation, make sure the two input passwords are same



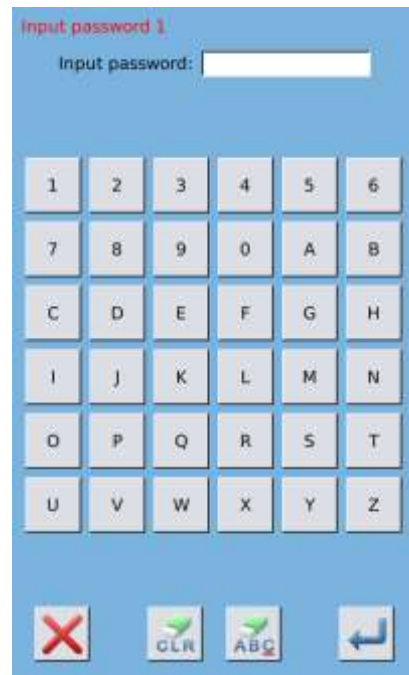

19) Input other periodical password

The setting of other periodical password is same to that in step ⑦. Please take the reference to that

- ※ **The next activation date shall be later than the previous date.**



20) Save Password

A、 After inputting the password, please press



to save it.

B、 After the password is saved, the system will display **【Save the password successfully】** . Press



to finish the operation and return to the main interface of information.

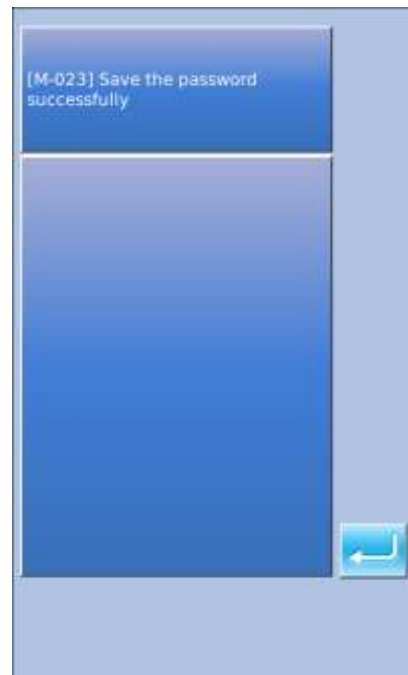

21) Clear Password before Activation

It is to clear the passwords before its activation.

A、 The method for entering the password interface

is same to that of the password setting

B、 Input the right factory ID to activate the right interface.

C、 The system will display current clock and the activation dates

D、 Press  to delete the password orderly

Input the right periodical password to clear the current password. If the super password is input, all passwords will be cleared;

After the deletion of the password, the date of that password will be displayed in **red**.

If all the passwords are cleared, the system will automatically quit to the main interface of information.



11 Clear Password at Activation

If the system has password and that password is still effective, it will be activated at the activation day.

If user wants to use the machine he should input the right password.

A、 The effective passwords include current password and super password

B、 If the current password is input, the current password will be deleted. After user clears the current password, if it is the last password in machine, no more activation of password will happen in future.

C、 If the super password is input, all the periodical passwords will be deleted.

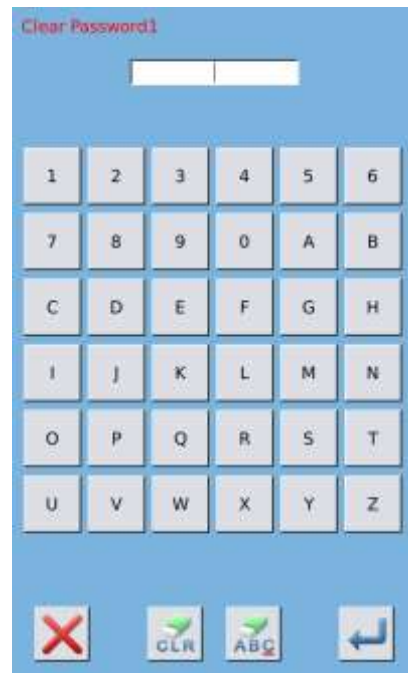

7 Communication Functions

At Communication, user can perform the following functions:

- Download the sewing data made at other sewing machines or produced by the pattern-designing software to the sewing machine;
- Load sewing data to U disk or computer
- Load parameters from U disk
- Input the parameters within the operation panel to U disk
- Update the software within the operation panel

7.1 About the Available Data

The available data is shown at below, as well as the data type:

Data Type	Standard Type
VDT	[0-9][0-9][1-9].vdt
DXF	[0-9][0-9][1-9].dxf
DST/DSB	[0-9][0-9][1-9].dst/ [0-9][0-9][1-9].dsb
B/BA	[0-9][0-9][1-9].(1-599)/ [0-9][0-9][1-9].(600-999)
PAT	[0-9][0-9][1-9].pat

When saving data to the U disk, user needs save it to the DH_PAT folder. Otherwise, the file is unable to be read.

7.2 Operations

① Display the Communication Interface

In the data input interface, press  to display the communication interface.

② Select the relating operations

The following three kinds of functions can be selected in this interface:

- Pattern Transfer
- Parameter Transfer
- Software Update

Click the corresponding figure to perform the operations.

③ Press to quit the Communication

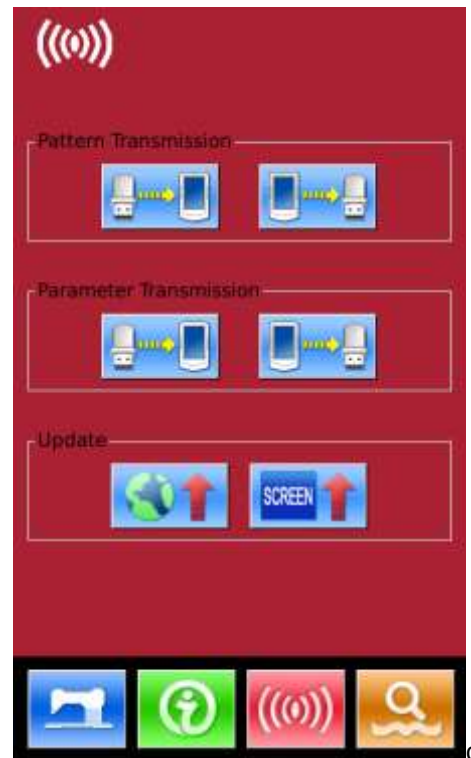

7.3 Pattern Transfer

① Display the Communication Interface

In communication interface, press:

A: Input patterns from U Disk to Operation Panel

B: Output patterns from Operation Panel to U Disk

Path of U Disk: DH_PAT

- ※ When inputting patterns from U disk, user has to save the pattern into the DH_PAT in the U disk.
- ※ When outputting patterns from operation panel, user has to save the pattern into the DH_PAT in the U disk.
- ※ Naming Method of Patterns within U Disk

When inputting patterns from U disk, user needs follow the naming rule at below::

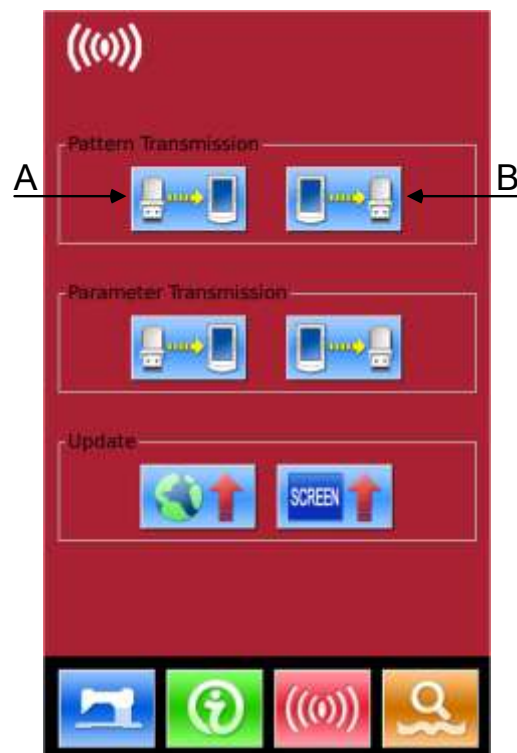

File Name: 3 figures, 001~999

Suffix: vdt (no matter at CAP or not)

Example:

Right Names: 100.vdt、102.VDT



Other naming methods are wrong, which can not be recognized by machine

② **Press button A to enter the interface for inputting patterns from U Disk**

Note: If the pattern in U disk has the same name to the pattern within the panel, the pattern number will be displayed in red. The pattern with red code can only be inputted with button F, as shown in figure 1

A、Use 【Up Arrow】 , 【Down Arrow】 to turn the page

B、Use these three methods to select patterns

- Press  to select all the patterns
- Press  to select in contrary way
- Input Pattern Number



C、Press  to finish pattern input. At this moment, the patterns inputted and the patterns selected share the identical pattern number, as shown in figure 2



Figure 1

D、 Press  to delete the selected pattern

E、 Press  to quit Communication Interface

F、 Select a pattern and then press  to display the interface shown as figure 3.

Input the pattern number for saving;

G、 If user selects several patterns, he will be unable to perform the above operation. Press  to quit to the previous r interface

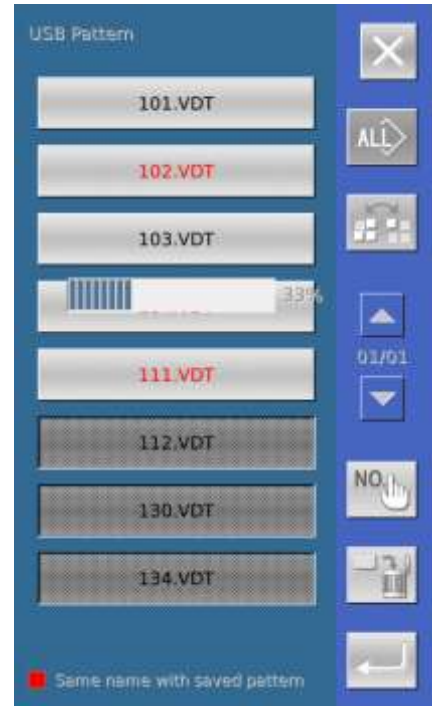

Figure 2

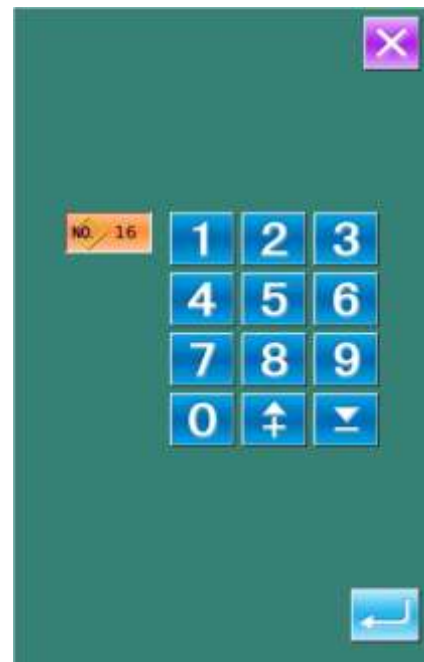

Figure 3

Attention: If the selected pattern number exists in operation panel, the screen as the figure 4 will be displayed. If the data is in other format, the panel will automatically turn it to the vdt format and save it into memory.





Figure 4

③ Press Button B to enter the interface for outputting patterns from panel to U Disk.

A、A、 Use 【Up Arrow】 , 【Down Arrow】 to turn the page

B、 Use these three methods to select patterns

- Press  to select all the patterns
- Press  to select in contrary way
- Input Pattern Number

C、 Press  to delete the selected pattern

D、 Press  to finish pattern output

E、 Press  to quit Communication Interface



F、 In this interface, press  to display the

free room of the memory and the number of pattern.

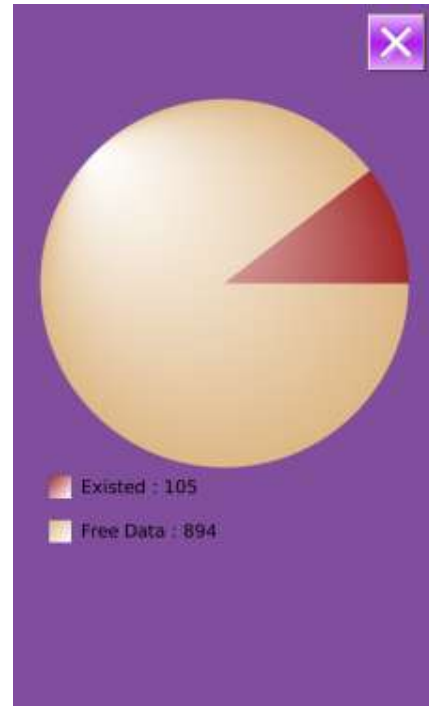

7. 4 Parameter Transfer

① Display the Communication Interface

In communication interface, press:

A: Input parameters from U Disk to Operation Panel

B: Output parameters from Operation Panel to U Disk

- ※ When inputting patterns from U disk, user has to save the parameters into the DH_PARA in the U disk with name ukParam.
- ※ When outputting patterns from operation panel, user has to save the parameters into the DH_PARA in the U disk with name ukParam.
- ※ The parameter file is the binary file, which is operated on the control panel. User can not change that file manually on PC, or the file may be damaged

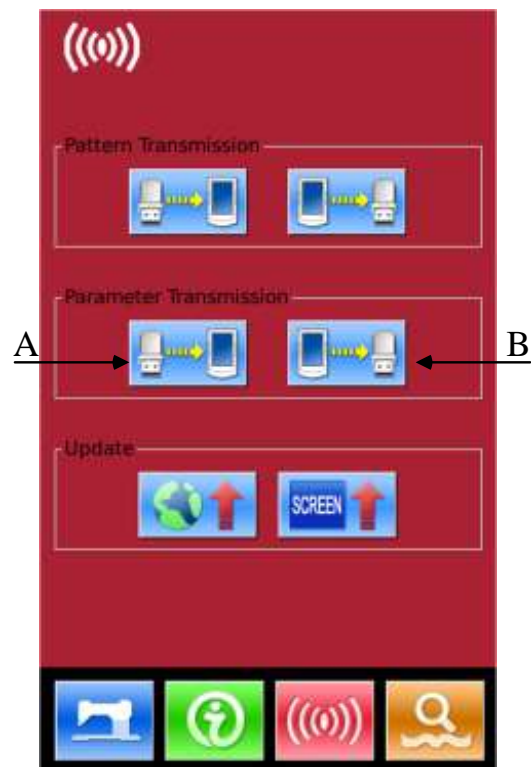

② **Press Button A to Input Parameters from U Disk to Operation Panel**

A、 Press  to input the parameters and quit

B、 Press  to quit directly.



③ **Press Button B to Output Parameters to Operation Panel**

A、 Press  to output parameters from operation panel to U disk and quit

B、 Press  to quit directly



7.5 Software Update

1) Display the Interface

In Communication interface, press A to enter Software Update Interface

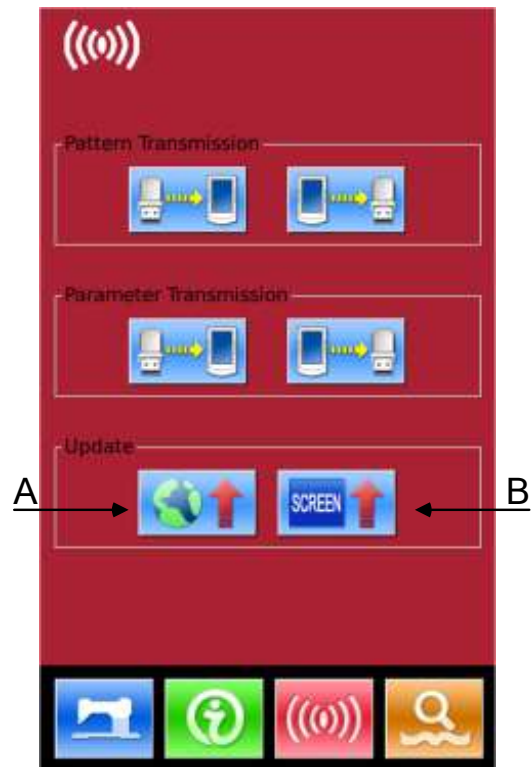

2) Update Selection

The software update contains:

- ◆ Operation Panel Software
- ◆ Icon
- ◆ Font
- ◆ Power-on Screen

Press  and  to turn the page

A、 Press  to finish the selected update and quit

B、 press  to quit directly

C、 User can select several items for update at same time. The system will perform the update according to the order

D、 After the update, please restart the machine.

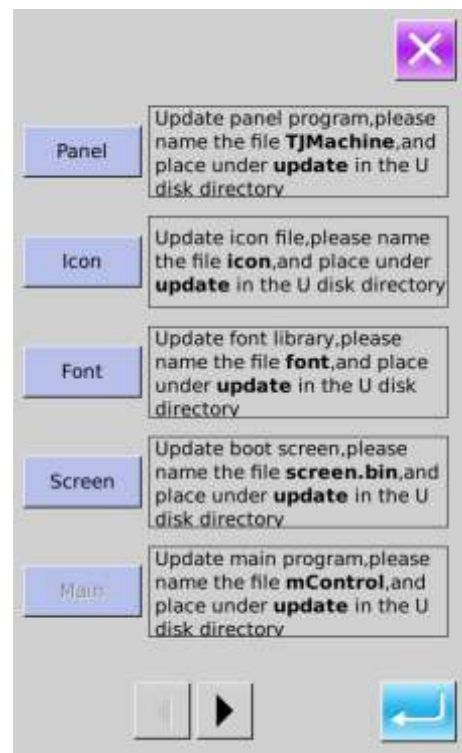

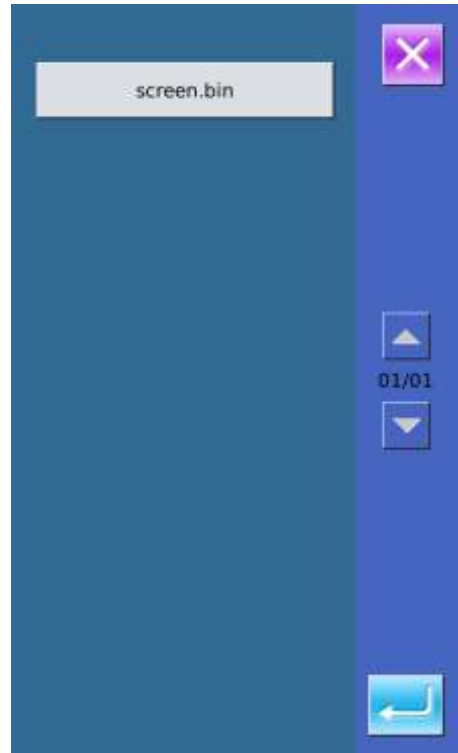

3) Press B to enter the interface for updating the power-on screen

Put the bin file (generated from the power-on screen) into the “Update” catalogue in U disk. Select the bin file and then press  to finish the update.



8 Mode & Parameter Setting

Press  to shift from the Data Input Interface to the Mode Interface (as shown in right figure), where user can perform some detailed settings and editions.

Hold  for 3 seconds to have access to Mode Setting Level 2 Interface; hold for 6 seconds to have access to Mode Setting Level 3 Interface.

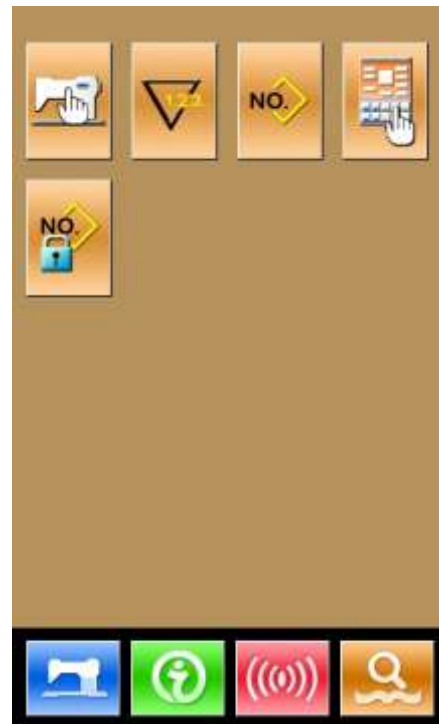

Mode Setting Level 2 Interface



Mode Setting Level 3 Interface

8. 1 List of Function Keys

No.	Figure	Functions	Content
-----	--------	-----------	---------

No.	Figure	Functions	Content
1		Level 1 Parameters Setting	Set the Level 1 (U) parameters
2		Counter Setting	Set the type of counter, counting value and default value
3		Sewing Type Setting	Shift between normal pattern sewing and combination pattern sewing
4		Pattern Lock	Enter the interface for locking pattern
5		Pattern Edition	Have access to pattern edition status
6		U Disk Initialization	Initialize the U disk.
7		Software Version Inquiry	Inquire the versions of the current panel, main controller and motor
8		Keyboard Lock	Lock some functions that can be set.
9		Test Mode	Set the mechanical devices and LCD
10	Parameter Back-up	Backup or recover the current parameters	
11		Activate Parameter Edition	Activate or deactivate the edition of parameters
12		Level 2 Parameters Setting	Set the Level 2 (K) parameters
13		Play Video	Play the video

8. 2 Level 1 Parameters Setting

① Set Parameter

Select  to enter the interface of Level 1 parameter setting (shown as the figure at right).

Press  to quit the setting interface. When some parameters are changed, the system will display the “Modified” in the parameter setting interface.

Select the parameter for changing; Then the system will enter the setting status. The parameters are separated as “Data Input Type” and “Selection Type”. Please refer to the example at below:



Select U01 and enter the interface below





Select U25 and enter the interface below



② Parameter Encryption

A、 Press “Encryption” to enter the password input interface.

Press  to clear all the content

Press  to erase one figure at each pressing

B、 Input the right password to enter the interface for parameter encryption

Select the parameter for encryption

Press **【Select All】** to attach password to all the parameters

Press**【Reverse】** to select parameter for encryption in reverse way

Press **【Change】** to change the password, the default is the manufacturer ID

Press  to quit the encrypting function

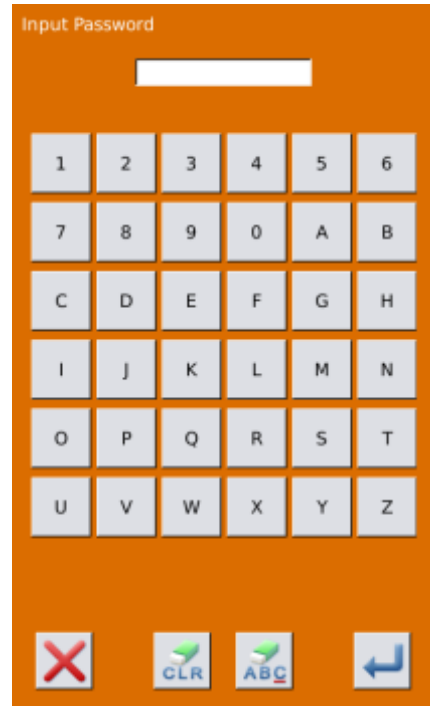

③ Check the changed parameter

- A、 When parameter is changed, the system will display “Modified” key at parameter setting interface.
- B、 In the parameter setting interface, press **【Modified】** to check the changed parameters.
At first, the system will ask user to input the password. For the operation at password input interface, please refer to the “A” at ②. After inputting the right password, user can enter the interface for inquiring changed parameters.
- C、 Under the interface of changed parameter inquiry, user can find the list containing all the changed parameters with their current value and default value.

In that interface:

- Press **【All Rest】** will restore all the changed parameters to their default values
- Click Parameter Name, like **【Presser Type】** and then press **【Select Rest.】** to restore this parameter to the default value. User can select many parameters at here.
- Press Parameter Number, like **【U14】** to enter the parameter setting interface, where user can reset the parameter value.
- When the pages are more than one, user can use arrow key to turn the page
- Press  to quit the interface.

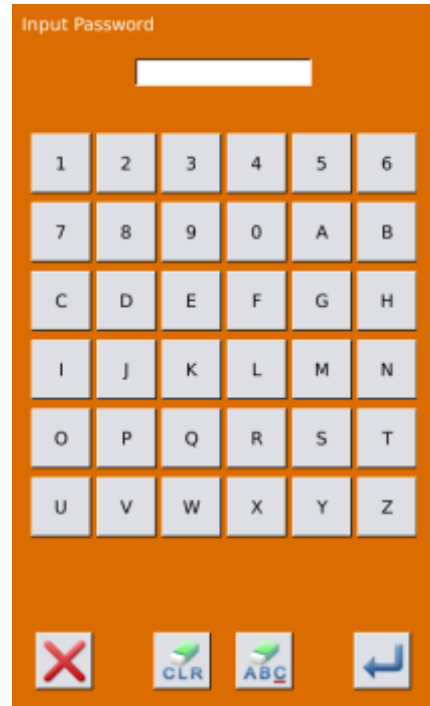

④ List of Level 1 Parameters

No.	Parameter	Range	Unit	Default value
U01	Max Sewing Speed	400~3000	100rpm	2700rpm
U02	Start Speed of 1 st Stitch (with thread-catching function)	400~1500	100rpm	1500rpm
U03	Start Speed of 2 nd Stitch (with thread-catching function)	400~3000	100rpm	3000rpm
U04	Start Speed of 3 rd Stitch (with thread-catching function)	400~3000	100rpm	3000rpm
U05	Start Speed of 4 th Stitch (with thread-catching function)	400~3000	100rpm	3000rpm
U06	Start Speed of 5 th Stitch (with thread-catching function)	400~3000	100rpm	3000rpm
U07	Thread Tension of 1st Stitch (with thread-catching function)	0~200	1	200
U08	Thread-tension at Thread-trimming	0~200	1	0
U09	Thread Tension Changeover Timing at Thread-trimming	-6~4	1	0
U10	Start Speed of 1 st Stitch	400~1500rpm	100rpm	400rpm
U11	Start Speed of 2 nd Stitch	400~3000rpm	100rpm	900rpm
U12	Start Speed of 3 rd Stitch	400~3000rpm	100rpm	2700rpm
U13	Start Speed of 4 th Stitch	400~3000rpm	100rpm	2700rpm
U14	Start Speed of 5 th Stitch	400~3000rpm	100rpm	2700rpm
U15	Thread Tension of 1st Stitch (No thread-catching function)	0~200	1	0
U16	Thread Tension Changeover Phase at Sewing Start	-5~2	1	-5
U25	Presser Height Division Switch ON: Permit Presser Height Division OFF: Forbid Presser Height Division	0: Permit Presser Height Division 1: Forbid Presser Height Division	1	1
U26	Adjustment of Divided Presser Height at 2 Levels' Stroke	50~90	1	70
U27	Counting Unit of the Sewing Counter	1~30	1	1
U31	Stop Sewing Machine with Button on Panel OFF: Invalidity	0: Invalidity 1: Pause Key at	1	1

No.	Parameter	Range	Unit	Default value
	PANEL: Pause Key at Panel EXT: External Switch	Panel 2: External Switch		
U32	Settings on Buzzer Sound OFF: Silence PAN: Operating Sound ALL: Operating Sound + Alarm	0: Silence 1: Operating Sound 2: Operating Sound + Alarm		2
U33	Number of Releasing Stitch at Thread-catching	1~7	1	2
U34	Display Phase at Thread-catching	-10~0	1	-5
U35	Thread-catching Switch ON: Permit OFF: Forbid	0: Permit 1: Forbid	1	1
U36	Select Time for Feeding Actions	-8~16	1	12
U37	Presser Status at Sewing End 0: Return and then lift presser 1: Lift presser and then return 2: step the pedal first and then lift the presser	0: Return and then lift presser 1: Lift presser and then return	1	1
U38	Presser Goes Up at Sewing End ON: Presser Up Permitted. OFF: Presser Up Forbidden	0: Presser Up Permitted. 1: Presser Up Forbidden.	1	0
U39	Whether to search origin after sewing (combination sewing not included) OFF: Not Search ON: Search	0: Not Search 1: Search	1	0
U40	Origin-Searching at Sewing Combination Patterns OFF: Not Search Origin PAT: Search Origin at Finishing Each Pattern	0: Not Search Origin 1: Search Origin	1	0

No.	Parameter	Range	Unit	Default value
	CLC: Search Origin at Finishing Each Cycle	at Finishing Each Pattern 2: Search Origin at Finishing Each Cycle		
U41	Search Origin at Shifting P Pattern OFF: Invalid ON: Valid	0: Invalid 1: Valid		0
U42	Needle Rod Stop Position UP: Upper Position DEAD: Highest Point	0: Upper Position 1: Highest Point	1	0
U46	Permit Trimming the Thread ON: Permit OFF: Forbid	0: Permit 1: Forbid	1	0
U49	Winding Speed Setting	800~2000	100rpm	1600rpm
U64	Select Unit for Size Change %: Input Percentage SIZ: Input Actual Size	0: Input Percentage 1: Input Actual Size		0
U88	Scale Mode OFF: Forbidden PIT: Change at Stitch Pitch STI: Change at Stitch Number	0: Forbidden 1: Changes at Stitch Pitch 2: Changes at Stitch Number		1
U97	Thread-trimming Method after Pause AUT: Automatic MAN: Manual	0: Automatic 1: Manual	1	0
U135	Return to Start Point or Origin at Sewing End	0: Start Point	1	0

No.	Parameter	Range	Unit	Default value
	0: Start Point 1: Origin	1: Origin		
U190	Back Light Auto Off OFF: Not Auto Off ON: Auto Off	OFF : Not Auto Off ON: Auto Off		0
U191	Back Light Off Wait Time	1~9	1m	3m
U192	Back Light Adjustment	20~100		100
U193	Modify the Counter Value OFF: Permit ON: Forbid	0: Permit 1: Forbid		0
U194	Operation at Reaching set value of Counter OFF: Stop Sewing ON: Continue Sewing	OFF: Stop Sewing ON : Continue Sewing		0
U195	Voice Column	30~63		50
U200	Language 0: Chinese 1: English	0: Chinese 1: English		0
U201	Set Language at Power-on OFF: No ON: Yes	OFF: No ON: Yes		0
U212	Presser Down Order at Separating Valves 0: Same Time 1: Left then Right 2: Right then Left	0: Same Time 1: Left then Right 2: Right then Left		0
U213	Presser Up Order at Separating Valves 0: Same Time 1: Left then Right 2: Right then left	0: Same Time 1: Left then Right 2: Right then Left		0

No.	Parameter	Range	Unit	Default value
U214	Reverse Presser OFF: Forbid ON: Enable	OFF: Forbid ON: Enable		1

8. 3 Level 2 Parameters Setting

① Parameter Setting

At Mode Setting Level 3 Interface, press  to have access to Level 2 Parameter Setting Interface (as shown in right picture). For the operation methods, please refer to descriptions at 8.2 Level 1 Parameters Setting.

When some parameters are changed, the system will display the “Modified” in the parameter setting interface.

Press  to quit the setting interface



② Parameter Encryption

For the operations, please refer to the description within “8.2 Level 1 Parameters Setting”

Press  to quit parameter encryption interface



③ Check the changed parameters

When parameter is changed, the system will display “Modified” key at parameter setting interface

In the parameter setting interface, press **【Modified】** to check the changed parameters.

User can also reset the parameters here.

For the specific operation, please refer to “8.2 Level 1 Parameter Setting”

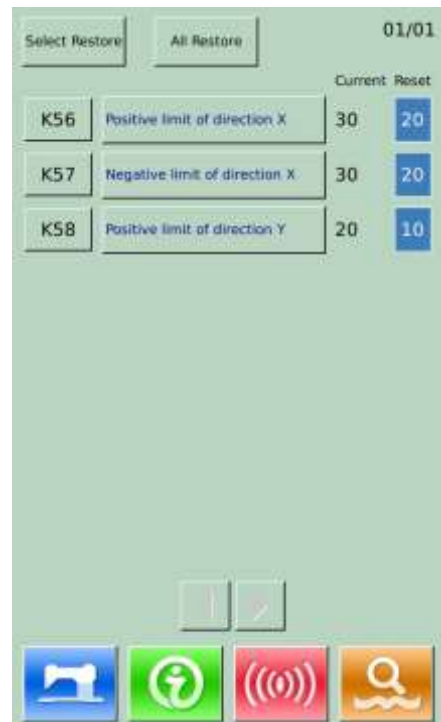

④ List of Level 2 Parameters

No.	Parameters	Range	Unit	Default
K01	Pedal Selection 0: Simulate 2: Double Pedals 3: Double Pedals, only the operation pedal can control machine	0: Simulate 2: Double Pedals 3: Double Pedals, only the operation pedal can control machine	1	0
K02	Presser Control 0: No Presser Control 2: Presser Controlled by Solenoid 3: Presser Controlled by Mechanism	0: No Presser Control 2 : Presser Controlled by Solenoid 3 : Presser Controlled by Mechanism		0
K19	Presser Up Time	0~50 (For air valve only)	5	30
K21	Simulated Pedal Position 1	50~200	1	70
K22	Simulated Pedal Position 2	50~200	1	120
K23	Simulated Pedal Position 3	50~200	1	185
K27	Speed for Lowering Presser	100~4000pps	10pps	4000pps
K28	Speed for lifting Presser	100~4000pps	10pps	1500pps
K29	Speed for Lifting Presser at Sewing End	100~4000pps	10pps	3000pps
K43	Trimming Speed	300~700rpm	100rpm	400rpm
K44	Empty Feeding Control At Thread-trimming OFF: Ineffective ON: Effective	OFF: Ineffective ON: Effective	1	1
K45	Needle Guider Diagram at Controlling Empty Feeding	1.6~4.0mm	0.2mm	1.6mm

No.	Parameters	Range	Unit	Default
K56	Move Range +X Direction	0~50mm	1mm	20mm
K57	Move Range -X Direction	0~50mm	1mm	20mm
K58	Move Range + Y Direction	0~30mm	1mm	10mm
K59	Move Range -Y Direction	0~30mm	1mm	20mm
K64	Thread-stirring Method 0: By Solenoid 1: By Motor	0: By Solenoid 1: By Motor	1	1
K66	Number of pulse at Stirring Operation with Presser Linkage	30~60	1	45
K74	Selection of Solenoid/ Air-driven Presser AIR: Air-driven Presser MOTO: Motor Presser	AIR: Air-driven Presser MOTO: Motor Presser	1	1
K95	Trimming Angle	-10~10	1	0
K112	Stop Position Compensation	-10~10	1	0
K122	OC	-128~128	2	0
K123	OD	-128~128	2	0
K124	BD	-512~512	4	0
K125	OC	184.5~244.5	0.1	208
K126	OD	144.6~204.6	0.1	174
K127	BD	39~59	0.1	53
K128	Stepping Control Method	0: DSP1 Close Loop, DSP2 Close Loop 1: DSP1 Opean Loop, DSP2 Close Loop 2: DSP1 Close Loop, DSP2 Opean Loop 3: DSP1 Opean Loop, DSP2 Opean Loop	0~3	1

No.	Parameters	Range	Unit	Default
K135	Solenoid Junction Delay	-10~30		
K137	Solenoid Thread-catching Angular Deflection	-150~150		
K138	Solenoid Suction Delay	-1~1		
K140	Thread Tension Control Method 0: Electronic Method 1: Mechanical Method	0: Electronic Method 1: Mechanical Method		
K141	Adjustment of Close Force at Branch Tension Solenoid	-20~20		
K142	Adjustment of Holding Force at Branch Tension Solenoid	-40~40	1	0
K144	Motor Thread-separating Delay (For Fang Zheng Only)	-15~15	1	0
K145	Motor Thread-trimming Delay (For Fang Zheng Only)	-10~10	1	0
K150	Head Safety Switch ON: Normal OFF: Forbid	ON: Normal OFF: Forbid		0
K200	Restore Default Settings			
K241	Type Setting Note: At changing the machine type, the system will re-add the basic patterns and delete the saved normal patterns	0: Bar-tacking Machine 5: 1906 Machine 7: Button Sewing Machine		0

8. 4 Counter Setting



Press  to have access to the Counter Setting Interface (as shown in right picture).

Procedure:

① Counter Selection

Select Sewing Counter or No.of Pcs Counter

② Set the Current Value and the Set Value of Counter

At the set type, press the “Current” or “Setting” to perform the relating operation.

③ Select Up Counter or Down Counter

At the selected type, please press “Up” and “Down” to perform the relating operations



Press  to quit counter setting interface



Press  to finish setting and quit.

Sewing UP Counter :

Every time the sewing of one shape is performed, the existing value is counted up 1. When the existing value is equal to the set value, the interface of counter exceed warning will be displayed. Press  to restore the existing value to 0

Sewing DOWN Counter :

Every time the sewing of one shape is performed, the existing value is counted down 1. When the existing value is reached to "0", the interface of counter exceed warning will be displayed. Press  to restore the existing value to the set value.

No of piece UP counter :

Every time a cyclic sewing or a continuous sewing is performed, the existing value is counted up 1. When the existing value is equal to the set value, the interface of counter exceed warning will be displayed. Press  to restore the existing value to 0

No of piece DOWN counter:

Every time a cyclic sewing or a continuous sewing is

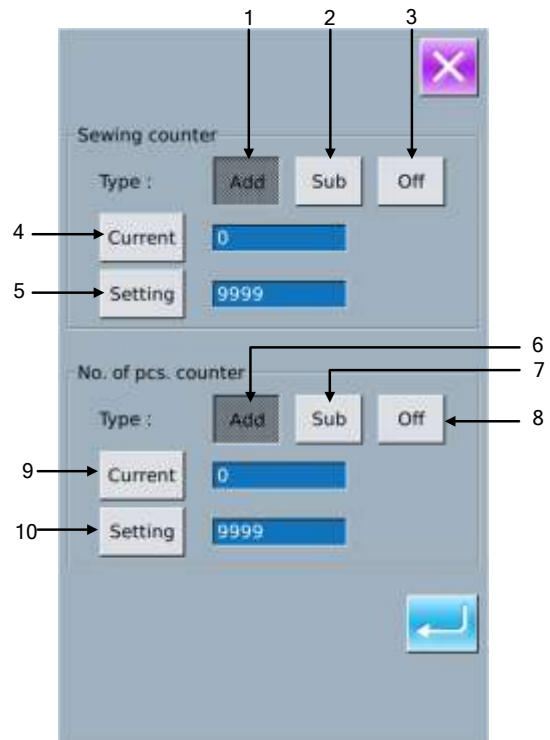

performed, the existing value is counted down 1. When the existing value is reached to "0", the interface of counter exceed warning will be displayed. Press  to restore the existing value to the set value.

④ Turn Off Counter

At the selected counter type, press “Off” to turn off the counter.

8. 4. 1 Functions

No.	Function
1	Sewing Add Counter
2	Sewing Down Counter
3	Sewing Counter Off
4	Set Current Sewing Counter Value
5	Set the Setting Value of Sewing Counter
6	No.of Pcs Add Counter
7	No.of Pcs Down Counter
8	No.of Pcs Counter Off
9	Set Current No.of Pcs Counter Value
10	Set the Setting Value of No.of Pcs Counter

8. 5 Change Sewing Mode



Press to enter the interface of sewing type selection



: Normal Sewing



: Cyclic Sewing

After confirming the sewing type, press to end the operation. Press , then the data input interface of the selected sewing type is displayed.



Press to quit and the original sewing type remains.



8. 6 Have Access to Pattern Edition



Press to shift between the following two figures. Select the corresponding mode and press to enter the pattern edition mode(Please refer to section 5.1)



: Sewing Mode

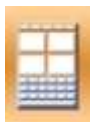



: Edition Mode



8. 7 Set Pattern Lock



In Setting Mode Level 1, press  to enter the interface for setting pattern lock, where the entire pattern number will be displayed. 32 pattern numbers are in each page. For locking a pattern, user only needs to press the pattern number. The selected pattern number will be displayed in dark.

Press  to save the setting. The selected patterns will be locked.

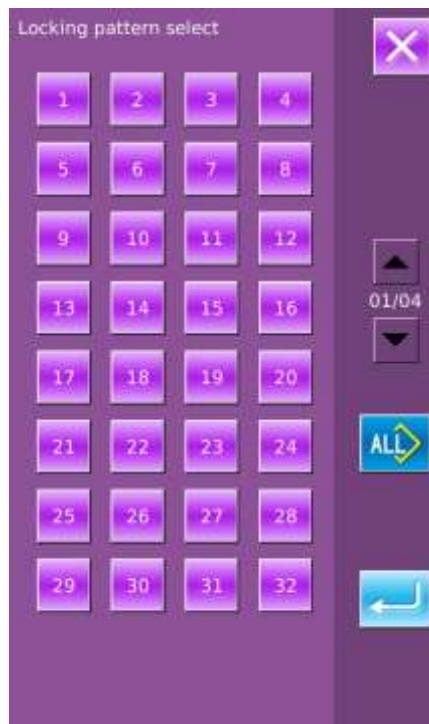

8. 8 Initialization



Press  to enter the interface for setting the keyboard lock.

In this interface, user can operate:

- U Disk Initialization
- Memory Initialization
- Customized Initialization
- P and C Pattern Initialization

Press the relating functions keys and enter the corresponding interface.

Press  to quit.



① Press “USB” to Initialize U Disk Files

Press  to initialize all the U disk files

Press  to quit U disk initialization



② Press “Memory” to initialize memory patterns

The following patterns can be initialized:

- Normal Pattern (Basic Patterns & User Patterns)
- Cyclic Sewing Pattern
- Registered P Pattern

Press  to initialize all the files in memory

Press  to quit

※Caution! This operation will delete all the patterns within the memory!

③ Press “Custom” to perform the batch deletion

In this interface, the system will display all the pattern files within the memory. Click the corresponding button to perform the batch deletion.

Operations at this function:

A. Use “Up Arrow”, “Down Arrow” to turn the page

B. Use the following three operations to select patterns

a) Press  to select all the patterns

b) Press  to select pattern in contrary way

c) Input pattern number

C. Press  to delete the patterns in batch

D. Press  to quit Initialization Interface



④ Under the Interface of Custom Initialization,

press  to display the free room of the memory and the number of patterns in each format.

Press  to return to the upper interface.

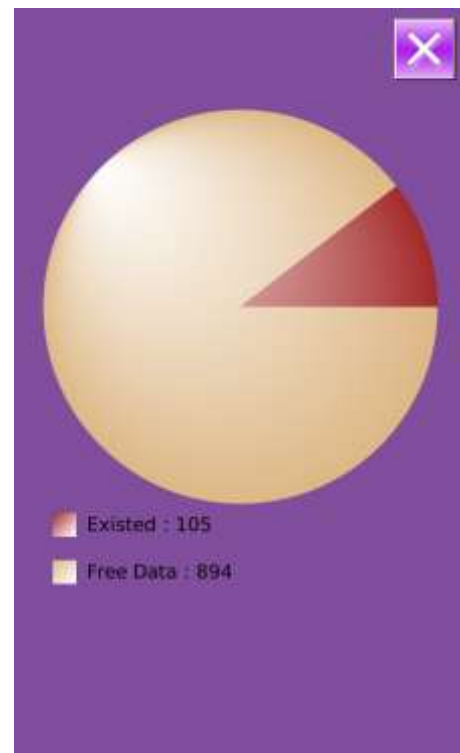

8. 9 Software Version Inquiry

At Mode Setting Level 2 Interface, user can press



to check the software version of system.



: Save the Current version information to the root

directory of U disk.



8. 10 Test Mode



At Mode Setting Level 2 Interface, user can press to have access to the Test Mode Interface (as shown in right picture)

The following is the list of each figure

No.	Name
A	I01 Touching Panel Correction
B	I02 LCD Test
C	I03 Input Test
D	I04 Speed Test
E	I05 Output Test
F	I06 Continuous Running
G	I07 XY Motor Origin Test
H	I09 Presser / Origin Sensor Test
I	Thread-catching Motor/ Origin Sensor Test

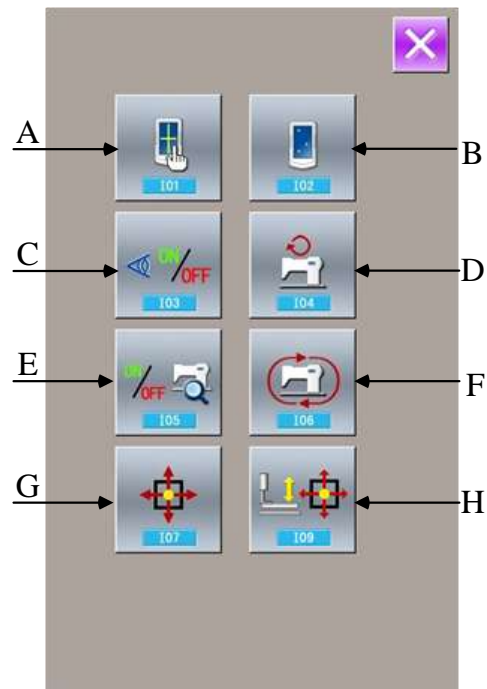

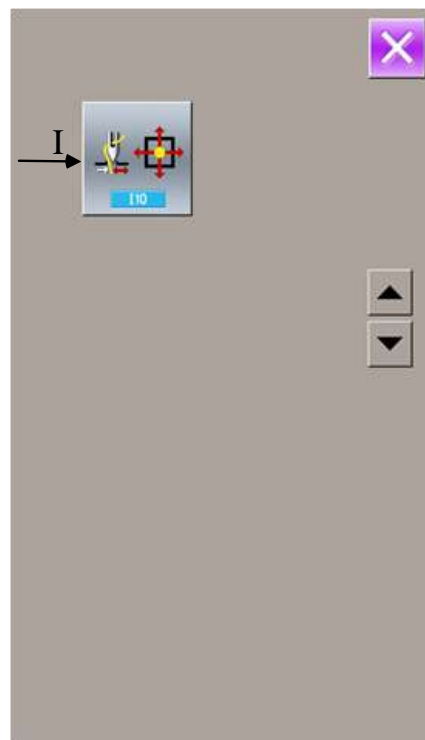

Press to quit the Test Mode interface



(1) Correction of Touching Panel

A、 In the interface of Mode Inspection, Press 

(I01 Correction of Touch Panel). Then system will hint user 【Enter Touching Panel Correction

Mode?】. Press  to enter the interface for Touch Panel Correction (as shown in right figure). Press  to quit the correction status.

B、 Because the corrections for five spots are needed, the user had better click the cross icon on the screen with tools like touching pen. After the correction, the system will tell user that this operation is successful or not.

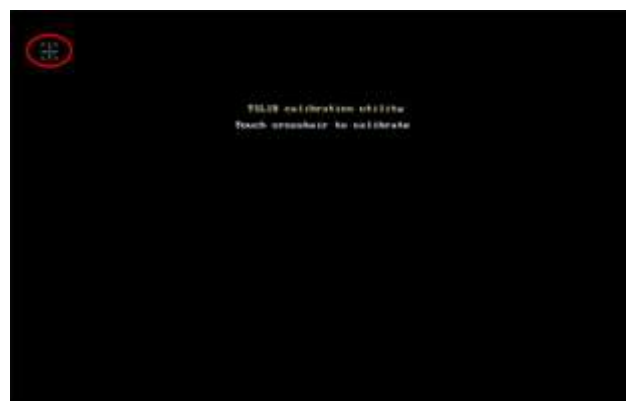

※ **During the correction, please do perform the operation according to the positions of crosses. Otherwise, the touching panel will be unable to**

work normally after the correction.

(2) Inspection of LCD Display

In the interface of Mode Inspection, press  (I02 Inspection of LCD Display) to enter the interface of LCD Display Inspection (as shown in right figure). Check whether the LCD fades in that status.

Touch the panel to have the screen display in the cycle of “Blue — Black — Red — Green — White”.

Press  to quit the interface of LCD Display Inspection



(3) Input Signal Test Method

In the interface of Test Mode, press  (I03 Input Inspection) to enter the interface of input inspection interface (as shown in right). Users can confirm the input status of each switch and sensor.

ON: Turn On

OFF: Turn Off

01: Start Switch

02: Presser Switch

03: Analog Pedal

04: X Motor Sensor

05: Y Motor Sensor

06: Origin Sensor of Outside-presser Motor

07: Sensor of Head Reversion

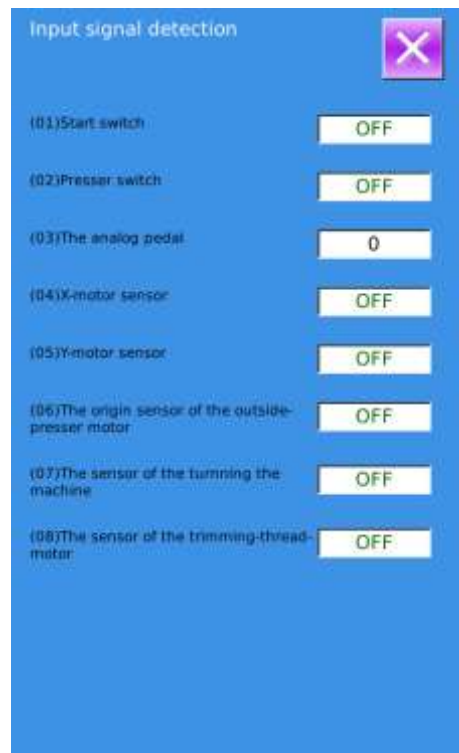

08: Sensor of Thread-trimming Motor



(4) Speed Test

① Interface for Speed Test

In the interface of Mode Inspection, Press  (I04speed test) to enter the interface for Speed Test (as shown in right figure). The speed of main shaft motor can be tested in that interface.

Press  to quit the interface for speed test.

② Speed Test Setting

Press “+” & “-” to set the speed of the main shaft motor. Press , then the motor will run at the set speed. At this moment, the actual tested speed is displayed in the interface.. Press  to stop the machine

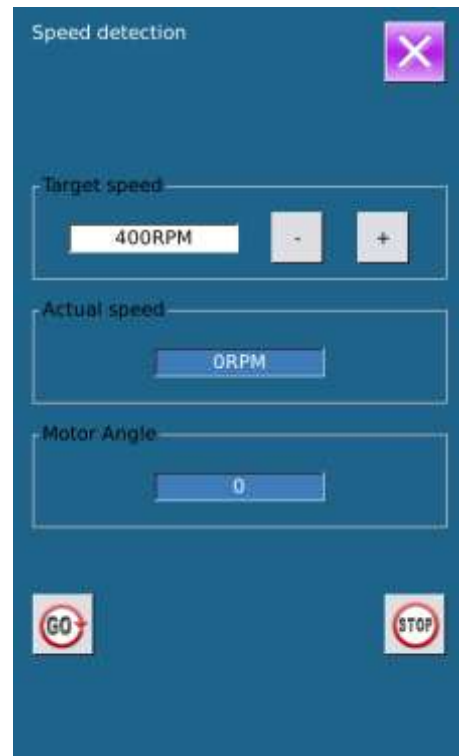

(5) Output Inspection

In the interface of Mode Inspection, Press  (I05 Output Inspection) to enter the interface of Output Inspection (as shown in the right figure). The following output status of the solenoid can be checked under that interface.

01: Thread-releasing Solenoid Test

02: Needle Thread Solenoid Test

Press  to quit output inspection interface

※Attention: Sewing machine will perform relating actions.



(6) Continuous Running

① Display the interface for continuous running

In the interface of Mode Inspection, Press  (I06 continuous running) to enter the interface of continuous running (as shown in right figure).

A: Action interval

B: Origin Detection

Press  to quit that interface.

② Continuous running setting

Click the columns under the interface of Continuous Running to set the Action interval and Origin Detection. Set the value with the number keys.

Press  and step the pedal to start the continuous running. During the running, user can use the pause switch to stop machine or he can stop machine by stepping the pedal or pressing pause switch at action end

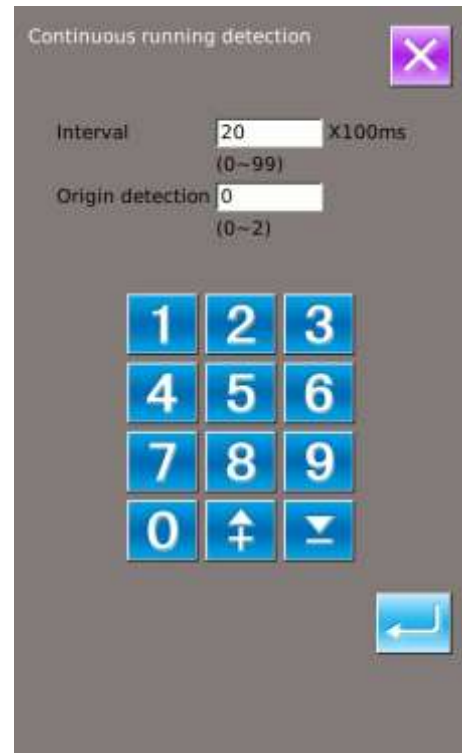



(7) XY Motor Origin Sensor Test

At Test Mode Interface, user can press  (I07XY Motor Origin Test) to activate XY Motor/Origin Output Test Interface (as shown in right picture). If user turns on the machine without entering the Ready

Status and pressing  to search the origin, user can directly press the direction keys to move the motor and display the On/Off statuses of Sensors at both XY sides. In this way, user can test the working condition of the XY Motor Driver and their sensors. If user enters

the Ready Status after power-on or presses  to

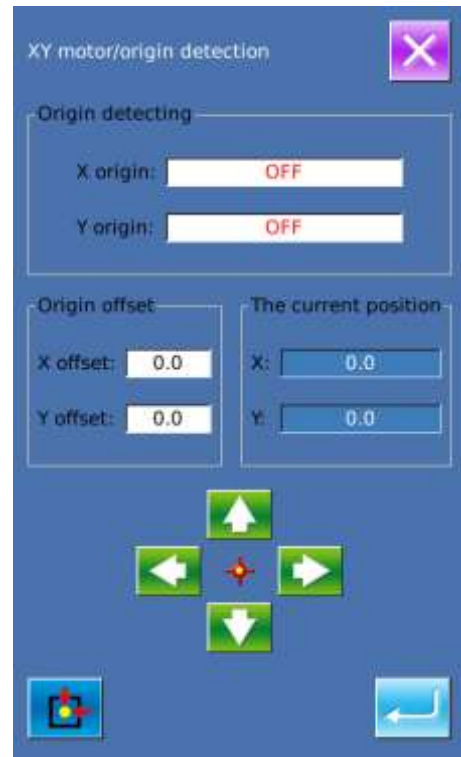

search origin, the user will have to press  to serach origin at each entry to the I07 mode in future so that he could use direction keys to move XY motors. This is the manual adjustment of the XY origin. The coordinates displayed at left is the deviation value of the origin, while the coordinates displayed at right is the current position of presser frame. User can press

 to set current position as the reference value of the origin.



(8) Presser Motor / Origin Sensor Detection

According to the status of the presser origin sensor, the position A displays the status (ON/OFF) of presser origin sensor; position B displays the status of trimming sensor.

By using  & , the user can drive the presser motor at each pulse

Additionally, pressing  is to drive presser motor to the position pointed at below, whose figure is displayed in dark.

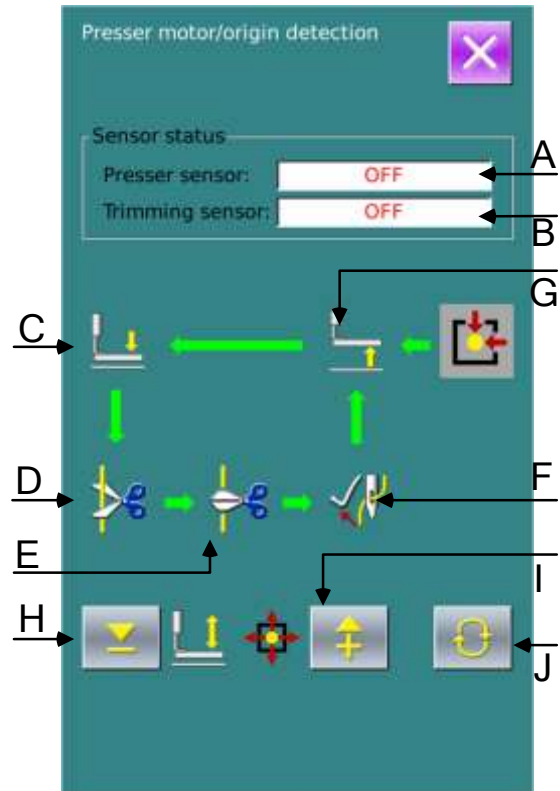

A: Presser Sensor B: Trimming Sensor

C: Presser down Position

D: Thread-trimming Wait Position

E: Trimming Finish Position

F: Thread-stirring Position

G: Presser Up Position

H: Forward one Step

J: Move to Next Position



I: Backward one Step

Note: Use Switch to search the origin of presser & thread-trimming motor, then this function will be effective.

(9) Thread-catching Motor/ Origin Sensor

Detection

According to the status of the presser origin sensor, the position A displays the status (ON/OFF) of thread-catching sensor; position B displays the status of thread-catching sensor.

By using  & , the user can drive the motor at each pulse

Additionally, pressing  is to drive thread-catching motor to the position pointed at below, whose figure is displayed in dark.

A: Catching Sensor B: Origin Sensor

G: Holding Position

C: Waiting Position

D: Catching Position

F: Release Position

H: Forward one Step

I: Backward one Step

J: Move to Next Position

Note: Use Switch to search the origin of thread-catching motor, then this function will be effective.

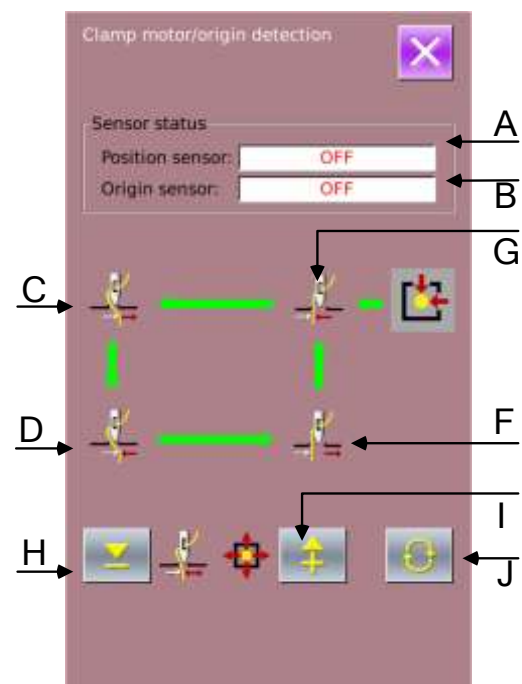

8. 11 Keyboard Lock

At Setting Mode Level 2 Interface, user can press



to activate Keyboard Lock Setting Interface.



① Operation for Keyboard Lock



: Keyboard Unlocked



: Keyboard Locked

Select  and then  to finish the operation of locking keyboard. Press  to quit the keyboard lock operation.



② Display of Keyboard Lock Status

Close Parameter Setting Mode Interface, and have system return to Sewing Data Input Interface (as shown in right picture.), where user can see a lock figure  under the pattern number. In the Keyboard Locked status, only the available figures can be displayed.

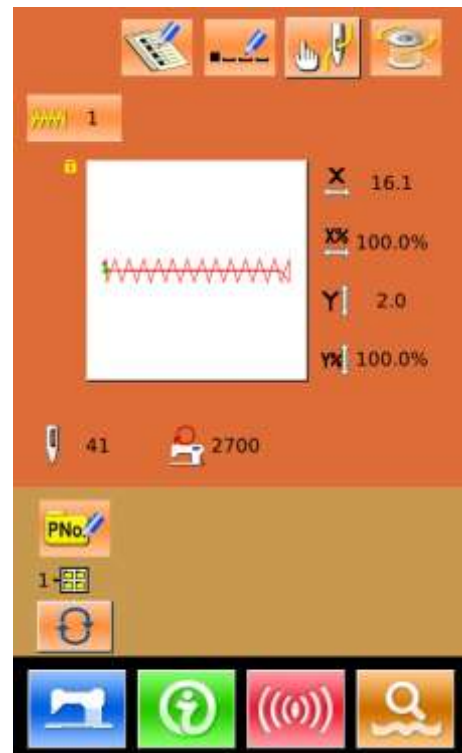

③ Range of Keyboard Lock

1、 Interface of Normal Sewing Data Input:

- 7) Pattern Registration
- 8) Pattern Naming
- 9) Scale Rate Setting
- 10) Max Speed Limitation
- 11) P Pattern Registration
- 12) Pattern Deletion

2、 Normal Sewing Interface:

3) Frame-moving

- 4) Counter Setting
- 3、 P Pattern Input Interface:
 - 2) P Pattern Edition
 - 2) P Pattern Copy
 - 3) P Pattern Naming
 - 4) Pattern Deletion
- 4、 P Pattern Sewing Interface:
 - 1) Counter Setting
- 5、 C Pattern Data Input Interface:
 - 6) C Patten Registration
 - 7) C Pattern Copy
 - 8) C Pattern Naming
 - 9) C Pattern Edition
 - 10) Pattern Deletion
- 6、 C Pattern Sewing Interface:
 - 1) Counter Setting
- 7、 parameter Setting Mode:
 - 3) Level 1 Parameter
 - 4) Level 2 Parameter
 - 3) Counter edition
 - 4) Test Mode
- 5): Pattern Lock Setting

8.12 Parameter Back-up

In setting mode level 3, press  to enter the interface of parameter back-up & restoration, as shown in right:

Clear: Clear all the customized parameters that are saved.

Save: Save current parameters

Restore: Restore the current parameters

① Click any key among  ~

 to set the position for saving the parameter. And then press 「Save」 to save that parameter.

② Check the content on 「Custom xx (On/Off)」. If 「On」 is displayed in bracket, that means this position has the user parameter, for an example

.

③ Select the button with parameters, press 「Restore」 to reload the corresponding parameter values

④ Press 「Clear」 to delete all the saved parameters

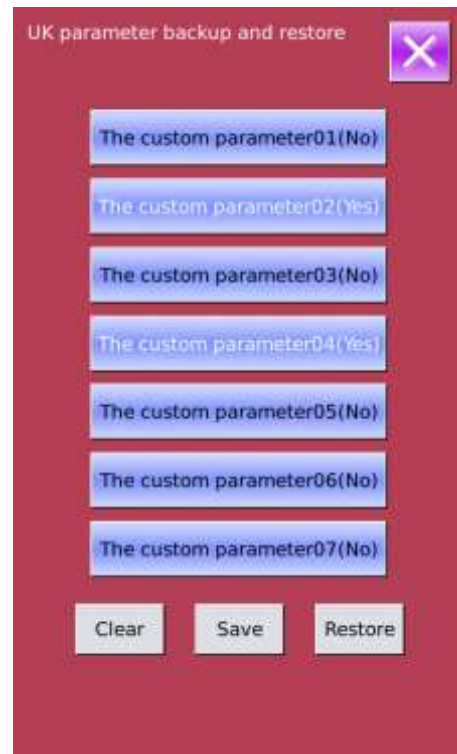

8.13 Button-stitching Function Setting

① Parameter Setting Operation

At Setting mode Level 3 Interface, user can press



to have access to Level 2 Parameter Setting

Interface (as shown in right figure). For the operating methods, please refer to the descriptions in Level 1 or 2 Parameter Setting. Press Key K241 to activate the next interface

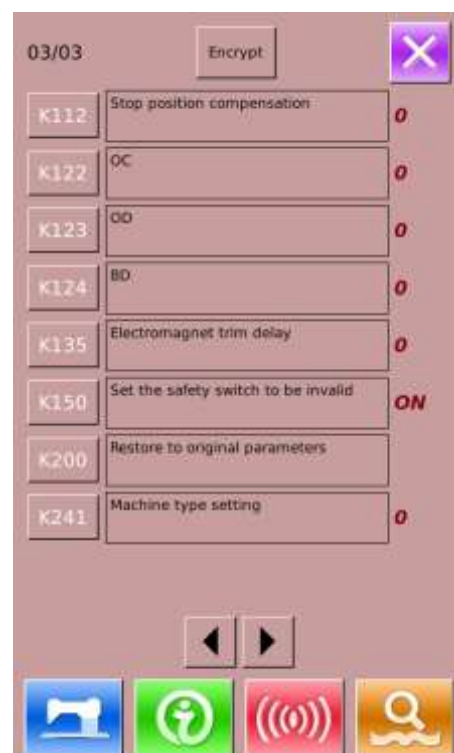



The right figure is the model selection interface. Press 7 to select button sewing function.

Press  to finish the selection.

Note: When the model is changed, the system will clear the entire saved pattern and reload the pattern for the newly selected model. Therefore, users have to pay attention to the back-up of patterns before changing the model.



At this moment, the Hint Interface will be displayed,

as shown in right picture. Pressing  is to cancel the settings, while pressing  is to confirm clearance of the existed patterns in the old model.

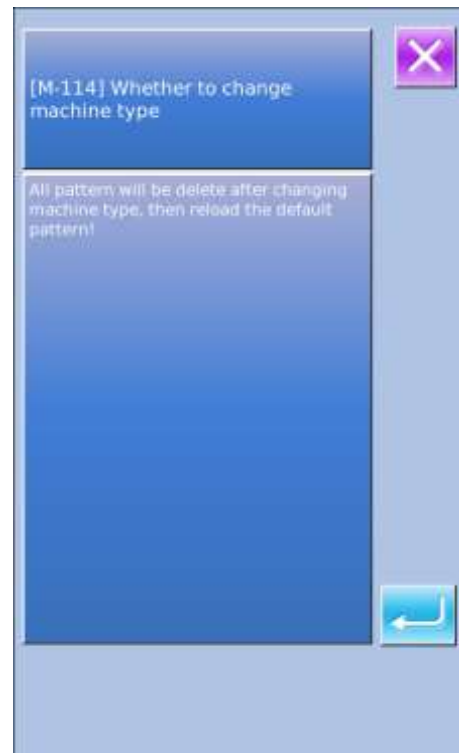

After clearing the pattern of old model, user has to turn off power, as shown in the right picture.



Re-power the machine. The hint interface for reloading patterns of new model will be displayed, as shown in the right picture. The user only needs to

press .



When loading the basic patterns for the new model successfully, the system will activate the Main Interface of Pattern N, as the right picture shows.

Button-sewing function is set successfully !



8.14 Pattern Edition Parameter Setting

At Setting Mode Level 3 Interface, user can press



to activate the Interface for Setting Pattern Edition Parameters.

The figures of the available functions are displayed in dark, while the figures of the unavailable functions are displayed with highlight.

Edit the parameters according to your needs, press



to finish the setting.



9 Controller System Principle

9.1 Structure of Control System

9.1.1 Installation Size of Control Box

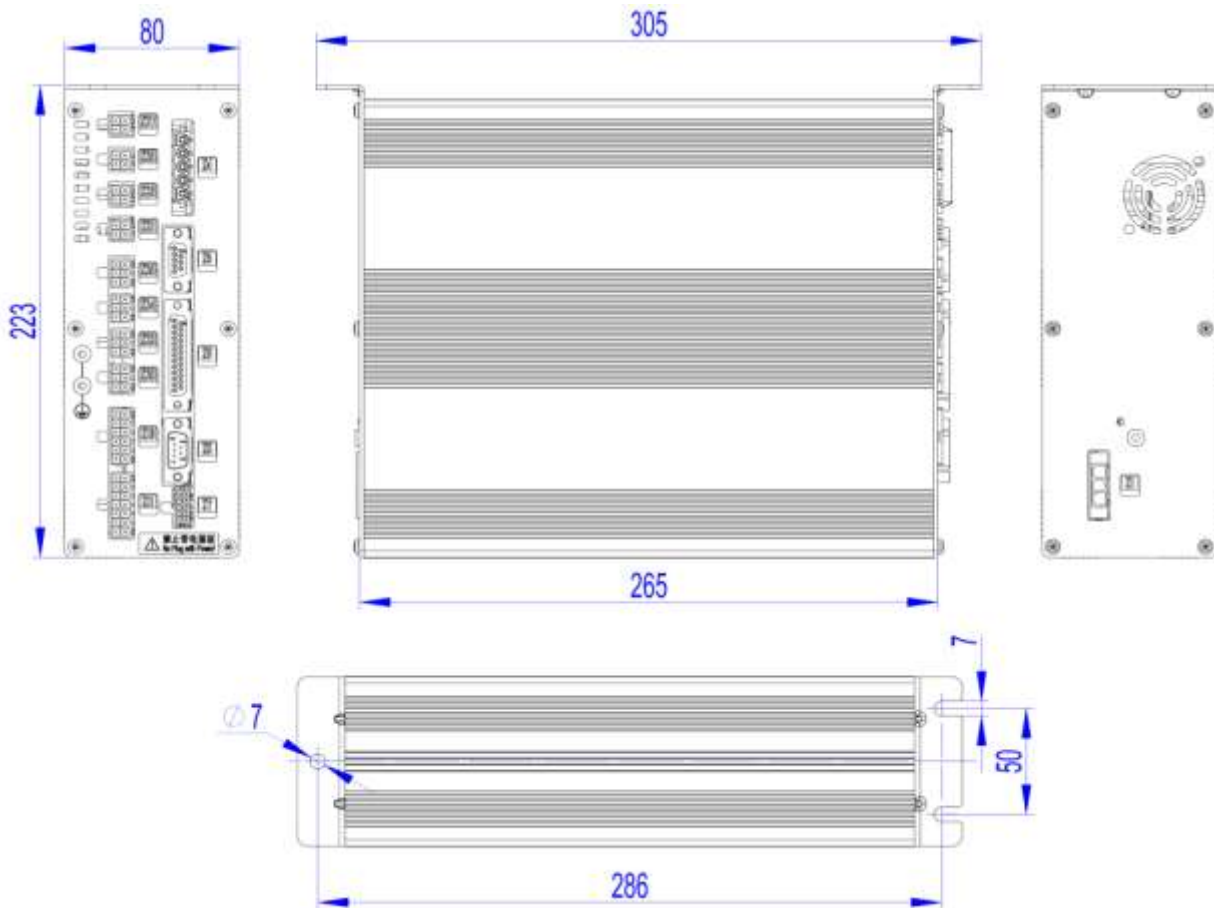

9.1.2 Installation Size of Operation Box

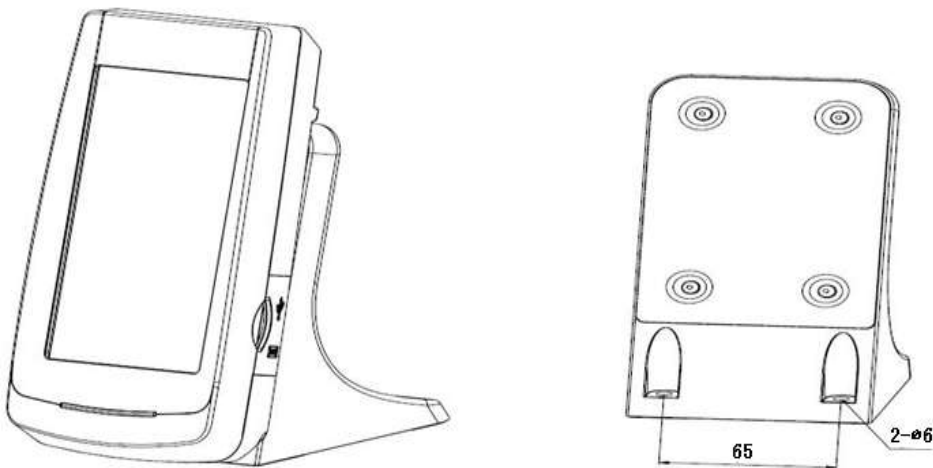

9.1.3 The Control System Diagram

1、MASC20X-2E-A Control System Diagram

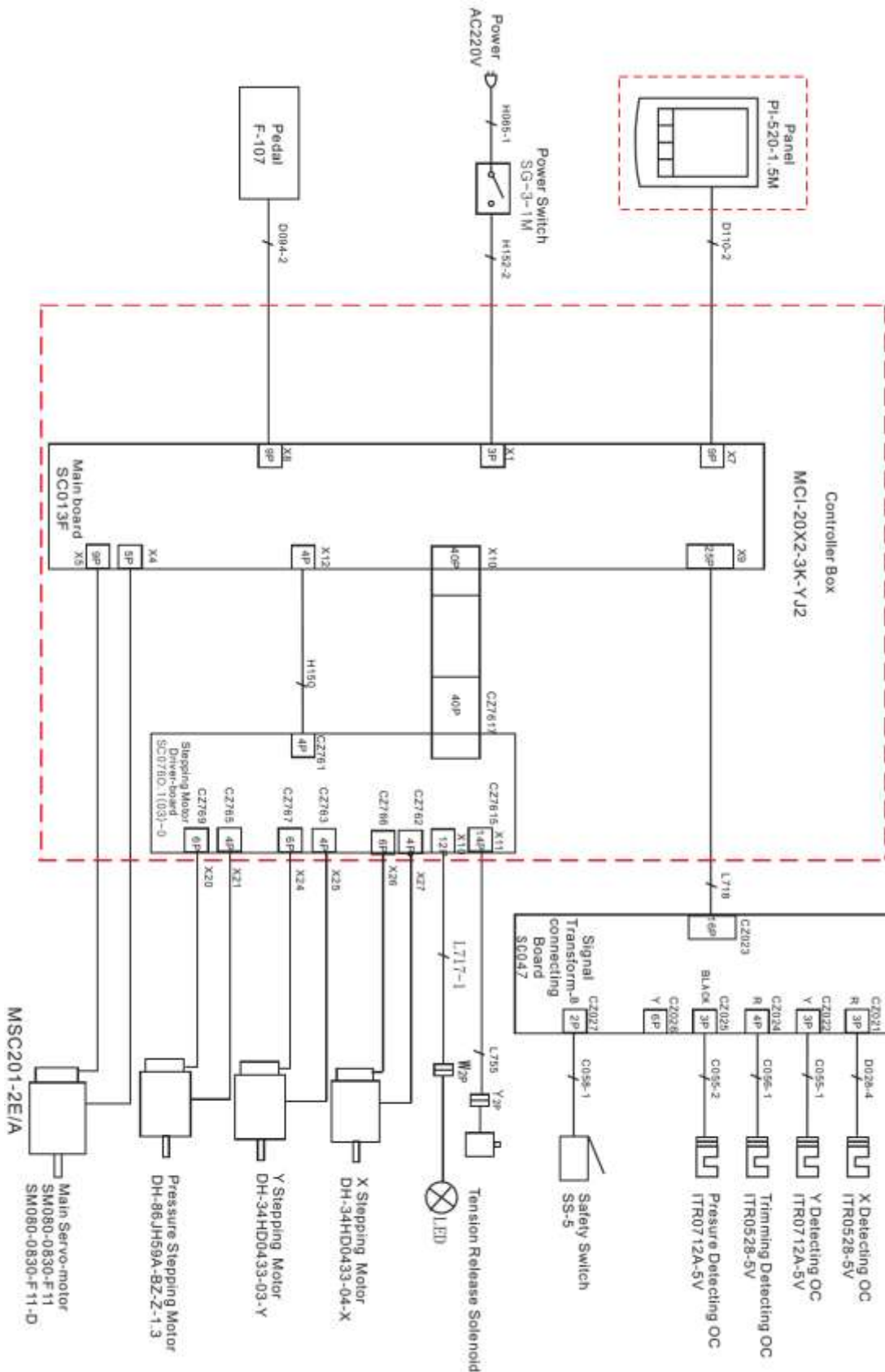

2、MSC20X-2E-A Control System Diagram

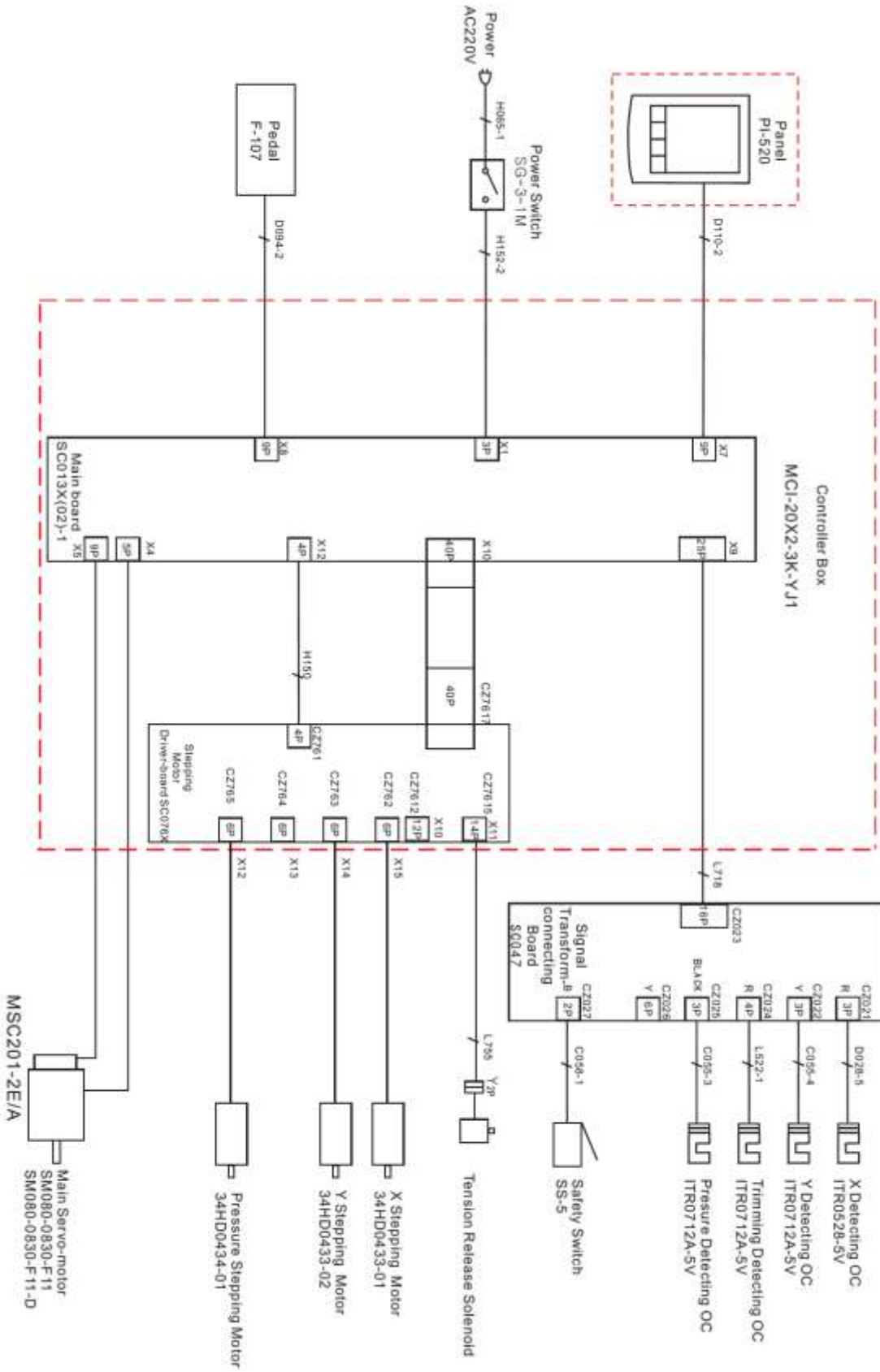

3、TSC20X-2E-A Control System Diagram

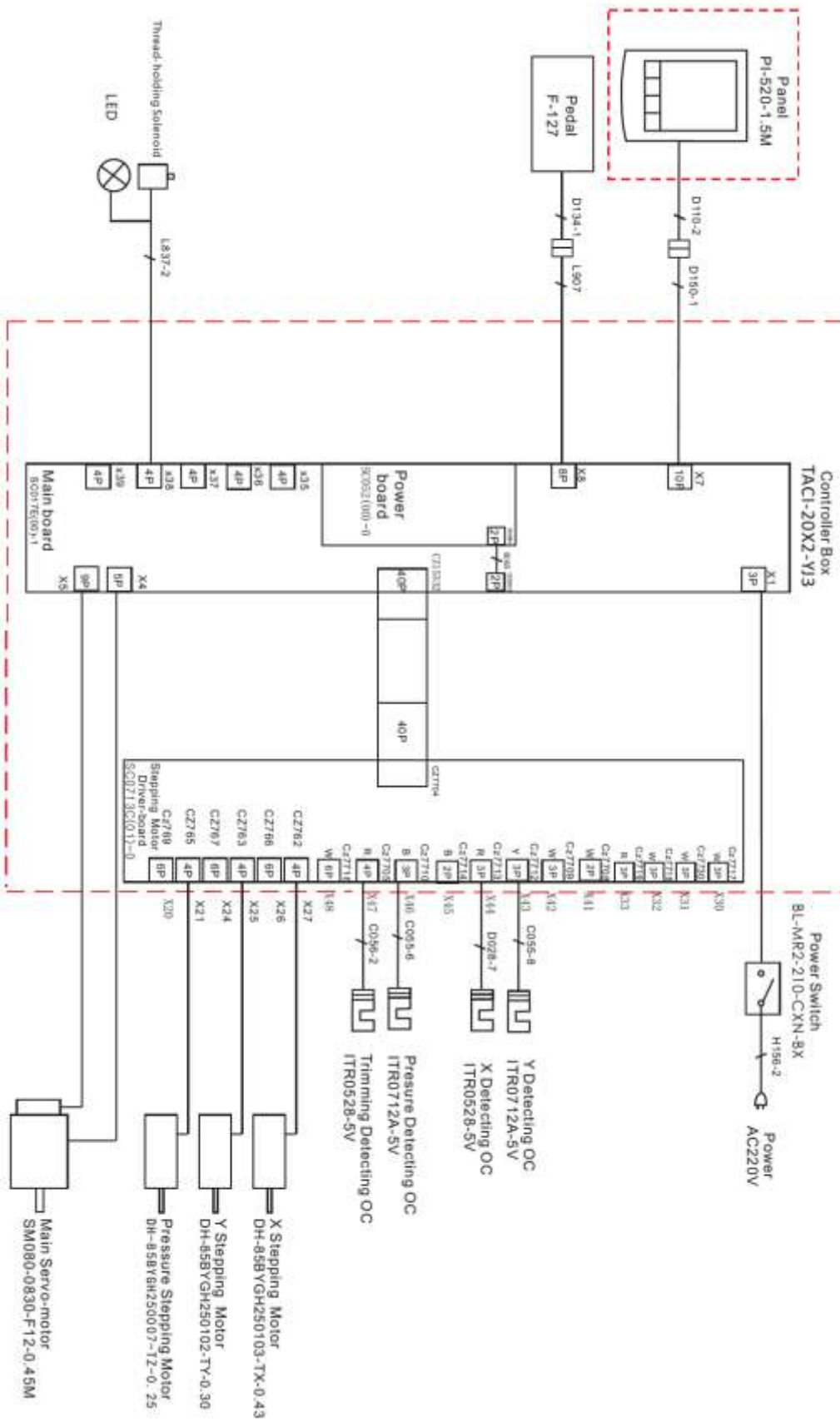

9.1.4 External Cable Connection of Control Box

1、MSC201 Control Box Back Wiring Interface Diagram

Note: Please take care to connect the pin of the external cable according to its corresponding number, referring to Picture .

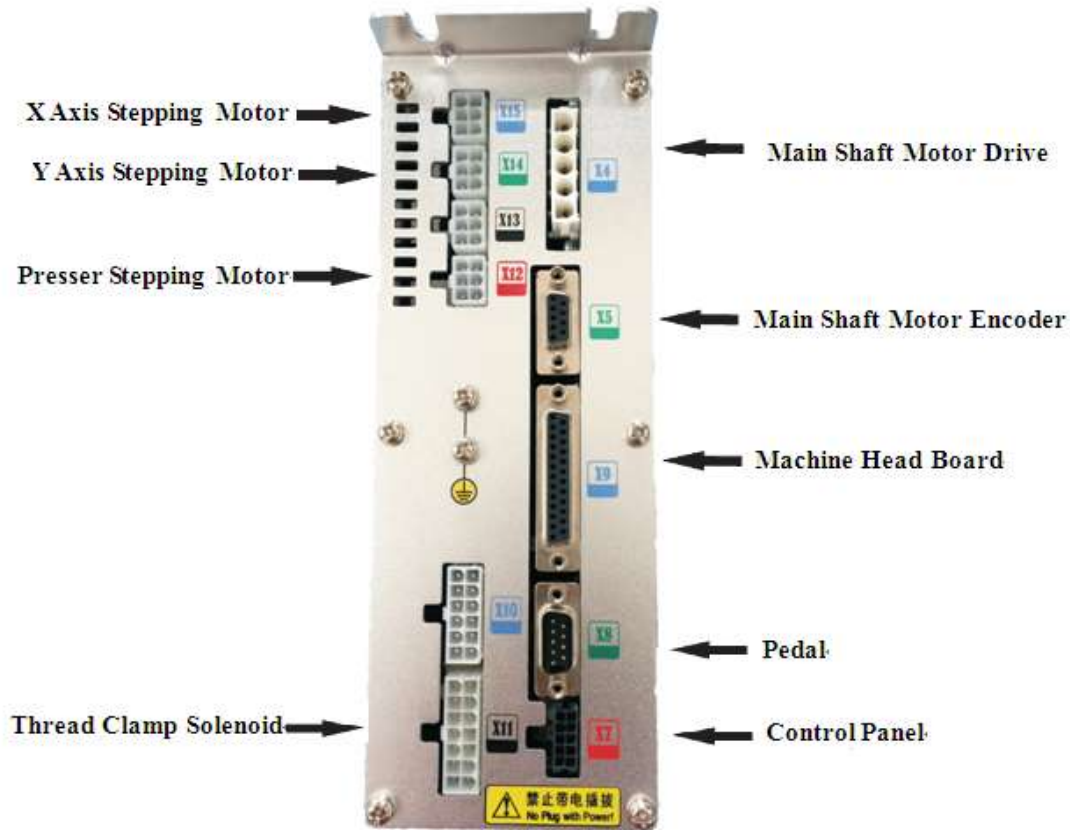



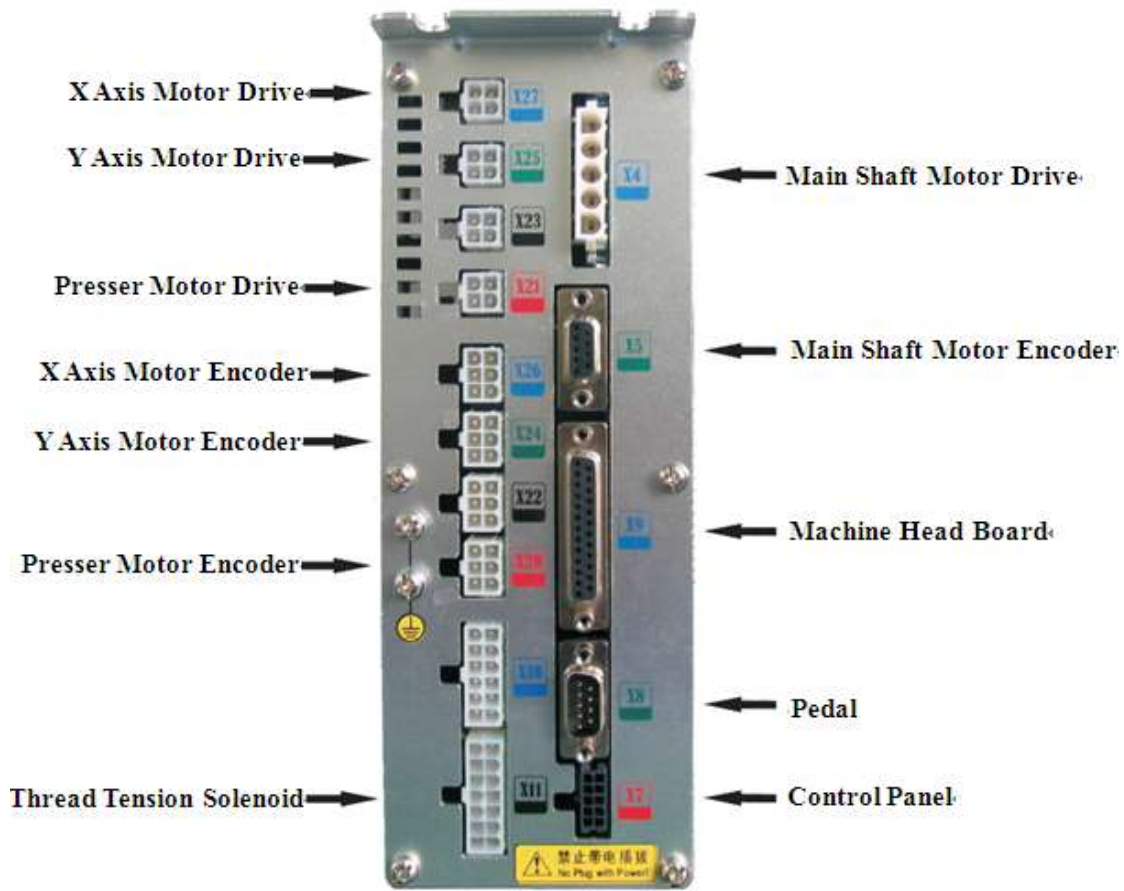





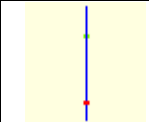
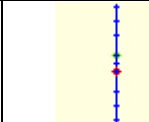
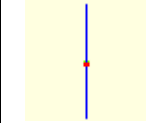
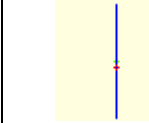

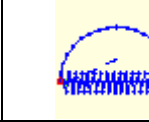

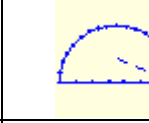
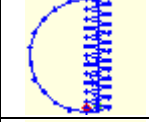
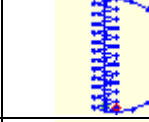

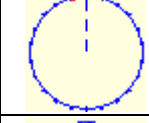
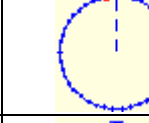
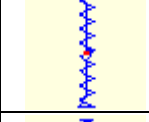
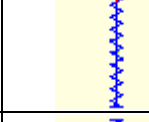

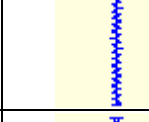
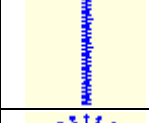
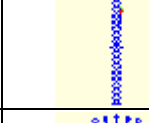











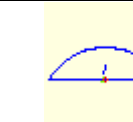
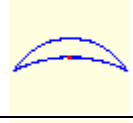
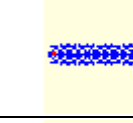
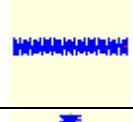

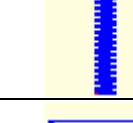
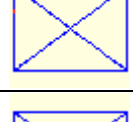
2、MASC201Control Box Back Wiring Interface Diagram

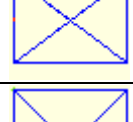
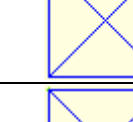
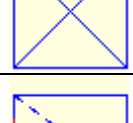
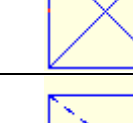



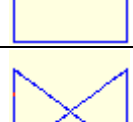

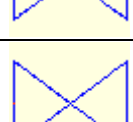
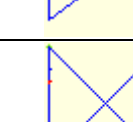
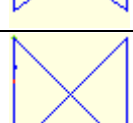
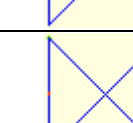
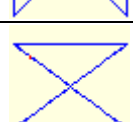

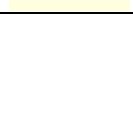
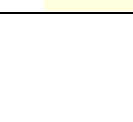

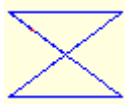

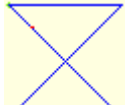



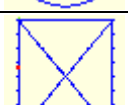
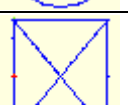

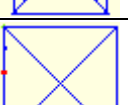
9.2 List of Patterns in 1900A Controller



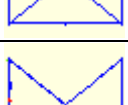





























NO.	Patterns	Stitch Number	Length × Width (mm)	NO.	Pattern	Stitch Number	Length × Width (mm)
1		41	16.1×2	2		41	10.2×2
3		41	16×2.4	4		41	24×3
5		27	10.1×2	6		27	16×2.4
7		35	10.1×2	8		35	16×2.4
9		55	24×3	10		63	24×3
11		20	6.1×2.4	12		27	6.2×2.4
13		35	6.1×2.4	14		14	8×2
15		20	8×2	16		27	8×2
17		20	10×0	18		27	10×0
19		27	25.2×0	20		35	24.8×0
21		40	25.2×0	22		43	35×0
23		27	4×20	24		35	4×20
25		41	4×20	26		55	4×20

27		17	0×20	28		20	0×10
29		20	0×20	30		27	0×20
31		51	10.1×7	32		62	12.1×7
33		23	10.2×6	34		30	12×6
35		47	7×10	36		47	7×10
37		89	24×3	38		27	8×2
39		25	11.8×12	40		45	12×12
41		28	2.4×20	42		38	2.4×25
43		38	2.4×25	44		57	2.4×30
45		75	2.4×30	46		41	2.4×30
47		89	8×8	48		98	8×8
49		147	8×8	50		163	8×8
51		110	7.9×7.9	52		120	7.9×7.9
53		130	7.9×7.9	54		51	12.4×10.2

55		50	12.4×10.2	56		52	21×6
57		57	21×6	58		102	19×3
59		115	40×5	60		115	40×5
61		93	5×30	62		109	5×30
63		108	40×30	64		80	40×30
65		64	40×30	66		96	30×30
67		76	30×30	68		60	30×30
69		52	40×30	70		40	40×30
71		32	40×30	72		44	30×30
73		36	30×30	74		28	30×30
75		60	40×30	76		48	40×30
77		36	40×30	78		56	30×30
79		44	30×30	80		36	30×30
81		67	40×30	82		51	40×30













83		39	40×30	84		55	30×30
85		35	30×30	86		42	30×30
87		32	30.1×30	88		26	30×30
89		74	20×24	90		54	20×24
91		65	20×20	92		49	20×20
93		39	20×20	94		63	25×20
95		51	25×20	96		45	25×20
97		42	25×20	98		33	25×20
99		27	25×20	100		88	30×25

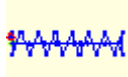
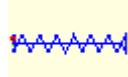

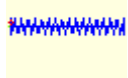
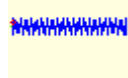
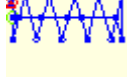
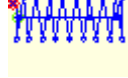



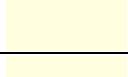
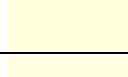



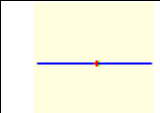
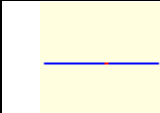

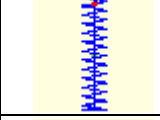
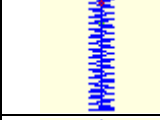
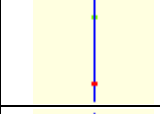
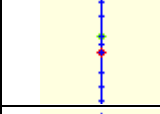
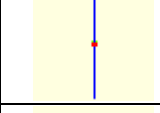
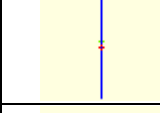
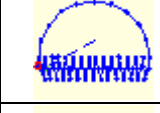
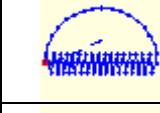
9.3 List of Patterns for Button-sewing in 1900B Controller

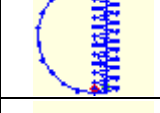

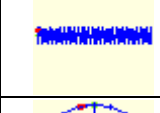
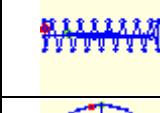

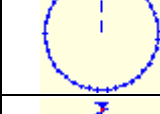
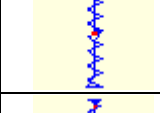
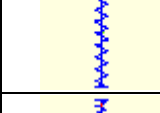
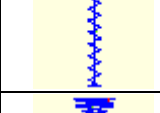
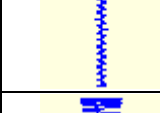





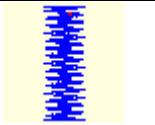
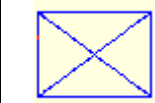



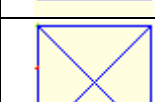

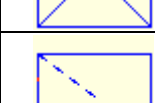







No.	Pattern	Thread Number	Standard Sewing Length X(mm)	Standard Sewing Length Y(mm)	No.	Pattern	Thread Number	Standard Sewing Length X(mm)	Standard Sewing Length Y(mm)		
1 34		6-6	3.4	3.4	18 44		6	3.4	0		
2 35		8-8			19 45		8				
3		10-10			20		10				
4		12-12			21		12				
5 36		6-6			22		16				
6 37		8-8			23 46		6			0	3.4
7		10-10			24		10				
8		12-12			25		12				
9 38		6-6	3.4	3.4	26 47		6-6	3.4	3.4		
10 39		8-8			27		10-10				
11		10-10			28 48		6-6				
12 40		6-6			29		10-10				
13 41		8-8			30 49		5-5-5			3.0	2.5
14		10-10			31		8-8-8				
15 42		6-6			32 50		5-5-5				
16 43		8-8			33		8-8-8				

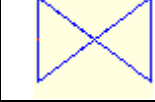

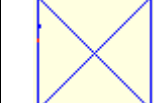





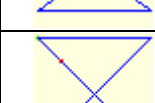
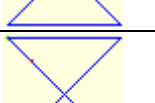

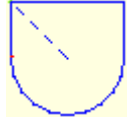
No.	Pattern	Thread Number	Standard Sewing Length X(mm)	Standard Sewing Length Y(mm)	No.	Pattern	Thread Number	Standard Sewing Length X(mm)	Standard Sewing Length Y(mm)
17		10-10							

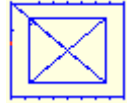
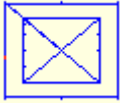
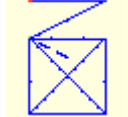
9.4 List of Patterns for Doubling Controller

NO.	Patterns	Stitch Number	Length × Width (mm)	NO.	Patterns	Stitch Number	Length × Width (mm)
1		41	16.1×2	2		41	10.2×2
3		41	16×2.4	4		41	24×3
5		27	10.1×2	6		27	16×2.4
7		35	10.1×2	8		35	16×2.4
9		55	24×3	10		63	24×3
11		20	6.1×2.4	12		27	6.2×2.4
13		35	6.1×2.4	14		14	8×2
15		20	8×2	16		27	8×2
17		20	10×0	18		27	10×0
19		27	25.2×0	20		35	24.8×0

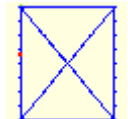
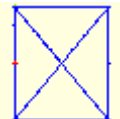
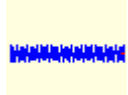
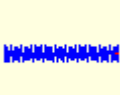
21		40	25.2×0	22		43	35×0
23		27	4×20	24		35	4×20
25		41	4×20	26		55	4×20
27		17	0×20	28		20	0×10
29		20	0×20	30		27	0×20
31		51	10.1×7	32		62	12.1×7
33		23	10.2×6	34		30	12×6
35		47	7×10	36		47	7×10
37		89	24×3	38		27	8×2
39		25	11.8×12	40		45	12×12
41		28	2.4×20	42		38	2.4×25
43		38	2.4×25	44		57	2.4×30
45		141	10×30	46		122	10×30
47		97	10×30	48		109	10.1×30

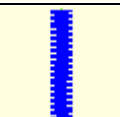
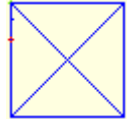
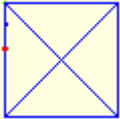
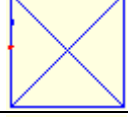
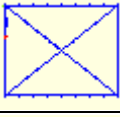
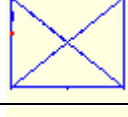
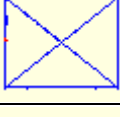
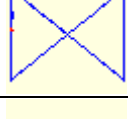
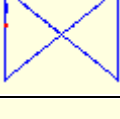
49		122	10.1×30	50		265	10×30
51		108	40×30	52		80	40×30
53		64	40×30	54		96	30×30
55		76	30×30	56		60	30×30
57		52	40×30	58		40	40×30
59		32	40×30	60		44	30×30
61		36	30×30	62		28	30×30
63		60	40×30	64		48	40×30
65		36	40×30	66		56	30×30
67		44	30×30	68		36	30×30
69		67	40×30	70		51	40×30
71		39	40×30	72		55	30×30
73		43	30×30	74		35	30×30
75		42	30×30	76		32	30.1×30

77		26	30x30		78		103	30x25
79		82	30x25		80		64	30x25
81		80	20x30		82		60	20x30
83		80	30x20		84		60	30x20
85		74	20x24		86		54	20x24
87		115	40x5		88		115	40x5
89		93	5x30		90		109	5x30
91		65	20x20		92		49	20x20
93		39	20x20		94		63	25x20
95		51	25x20		96		45	25x20
97		42	25x20		98		33	25x20
99		111	60x40		100		91	60x40

9.5 List of Warning

Code	Name	Release Method
E-001	Pedal is not at the middle position.	Check whether pedal is stepped at entering the Ready Sewing Interface
E-002	Machine is in emergency stop	Press to enter the Status of frame-moving at stop or press Reset Switch to trim thread and restart or return to origin.
E-003	Tilt of Machine Head Error	
E-004	Main voltage is too low (300V)	Please turn off the power and check the system hardware.
E-005	Main voltage is too high (300V)	
E-007	IPM over-voltage or over current	Please turn off the power and check the system hardware.
E-008	Voltage of assistant device (24V) is too high	Please turn off the power and check the system hardware.
E-009	Voltage of assistant device (24V) is too low	Please turn off the power and check the system hardware.
E-010	Valve (fan) problem	Please turn off the power and check the system hardware.
E-012	Presser Position Abnormal	Please turn off the power and check the system hardware.
E-013	Encoder error or unconnected	Please turn off the power and check the system hardware.
E-014	Motor running abnormal	Please turn off the power and check the system hardware.
E-015	Exceeds sewing area	Press Reset switch, and confirm the figure and X/Y scale rate。 Activating Condition: Software Pattern Error
E-016	Needle bar upper position abnormal	Press The wrong stop position of main motor may be caused by the main shaft driver or the manual rotation. Turn the wheel to return the needle bar to the upper position.
E-017	Thread breakage detection error	Press
E-018	Knife position abnormal	Please turn off the power.
E-019	Emergency switch is not at the right position	Self-recovery
E-020	Stepping software version error	Please turn off the power.
E-021	Machine is in emergency stop (Free)	Press Reset
E-022	Machine is in emergency stop (Ready)	Press Reset
E-023	Thread-catching position error	Please turn off the power.
E-024	Wrong connection between operation panel and sewing machine	Please turn off the power.
E-025	X origin detection abnormal	Please turn off the power.
E-026	Y origin detection abnormal	Please turn off the power.
E-027	Presser origin detection abnormal	Please turn off the power.
E-028	Thread-catching origin	Please turn off the power.

	detection abnormal	
E-029	Intermediate presser origin detection abnormal	Please turn off the power.
E-030	Stepping driver communication abnormal	Please turn off the power.
E-031	Stepping motor over-current	Please turn off the power.
E-032	Stepping driver power supply abnormal	Please turn off the power.
E-034	Abnormal current	Please turn off the power.
E-035	IPM frequent over-current 1	Please turn off the power.
E-036	IPM frequent over-current 2	Please turn off the power.
E-037	Motor blockage 1	Please turn off the power.
E-038	Motor blockage 2	Please turn off the power.
E-039	Motor over speed	Please turn off the power.
E-040	Stop over-current	Please turn off the power.
E-041	Motor overload	Please turn off the power.
E-042	Bus voltage abnormal	Please turn off the power.
E-043	Thread-trimming motor origin abnormal	Please turn off the power.
E-044	Head board EEPROM loading error	
E-045	Component abnormal	Please turn off the power.
E-046	CRC checking error	Please turn off the power.
E-047	Data checking error	Please turn off the power.
E-048	X checking error	Please turn off the power.
E-049	Y checking error	Please turn off the power.
E-050	MD1 stepping motor over-current	Please turn off the power.
E-051	MD1 X direction not finish	Please turn off the power.
E-052	MD1 Y direction not finish	Please turn off the power.
E-053	MD2 stepping motor over-current	Please turn off the power.
E-054	MD2 X direction not finish	Please turn off the power.
E-055	MD2 Y direction not finish	Please turn off the power.
E-056	Stepping close loop DSP1 communication error	Please turn off the power.
E-057	Stepping Close Loop DSP1 1st Route (X27) Over-current	Please turn off the power.
E-058	Stepping Close Loop DSP1 1st Route (X27) Position Error	Please turn off the power.
E-059	Stepping Close Loop DSP1 1st Route (X27) Over-speed	Please turn off the power.
E-060	Stepping Close Loop DSP1 2nd Route (X25) Over-current	Please turn off the power.

E-061	Stepping Close Loop DSP1 2nd Route (X25) Position Error	Please turn off the power.
E-062	Stepping Close Loop DSP1 2nd Route (X25) Over-speed	Please turn off the power.
E-063	Stepping Close Loop DSP2 communication error	Please turn off the power.
E-064	Stepping Close Loop DSP2 1st Route (X23) Over-current	Please turn off the power.
E-065	Stepping Close Loop DSP2 1st Route (X23) Position Error	Please turn off the power.
E-066	Stepping Close Loop DSP2 1st Route (X23) Over-speed	Please turn off the power.
E-067	Stepping Close Loop DSP2 2nd Route (X21) Over-current	Please turn off the power.
E-068	Stepping Close Loop DSP2 2nd Route (X21) Position Error	Please turn off the power.
E-069	Stepping Close Loop DSP2 2nd Route (X21) Over-speed	Please turn off the power.
E-070	Step drive board 90 power Over-current	Please turn off the power.
E-071	The lift head position is wrong	Please turn off the power.
E-072	Intermediate presser origin detection abnormal	Please turn off the power.
E-073	The XY needle is too wide spaced	Please turn off the power.
E-074 ~89	Stepping driver upgrade failure	
E-090	Query step state timeout	
E-091	Step Driver Version Error	
E-092	Stepping Driver Error	
E-093	Errors in Packet Checking of Step Closed-Loop DSP1 (X25/27) Communication	
E-094	Illegal Command of Data Packet in Step Closed-Loop DSP1 (X25/27) Communication	
E-095	Errors in Packet Checking of Step Closed-Loop DSP1 (X21/23) Communication	
E-096	Illegal Command of Data Packet in Step Closed-Loop DSP1 (X21/23) Communication	

E-097	The main control software does not match the hardware type of the main board	
E-098	CRC Checking Error of Step Drive DSP1 Curve	
E-099	CRC Checking Error of Step Drive DSP2 Curve	
E-100	System parameter version change, automatic initialization of all default system parameters	
E-101	Abnormal range of system parameters	
E-254	Undefined error	Undefined error

9.6 Hint List

No.	Name	Content
M-001	Can not find pattern data	Please reload or input from design software
M-002	Set value too large	Please input value within range
M-003	Set value too small	Please input value within range
M-004	Parameter save error	Press Enter to recover default setting
M-005	Communication error	Communication error between operation panel and control box
M-006	Fail to load letter sewing file	
M-007	Operation head not match to control box	Please check the model and the software version
M-008	Over Max stitch pitch	
M-009	Wrong password	Input again
M-010	Clock error	The hardware clock is down, please contact manufacturer for repair
M-011	Letter sewing pattern saved successfully	Enter the pattern selection interface and generate new letter sewing pattern
M-012	SRAM initialization	Clear all the data within SRAM, please turn off machine and restore the DIP switch
M-013	Turning off	
M-014	USB is pulled out	USB is pulled out
M-015	Can not find pattern in U disk	
M-016	At least input one letter	Periodical password has been set, can not change system time
M-017	No warning record	
M-018	Wrong user ID	Input again
M-019	Fail to confirm password	Input password again
M-020	Can not change system time	Periodical password has been set, can not change system time
M-021	Password file input error	
M-022	Password file load error	
M-023	Password save successful	

M-024	Clear all password failed	Can not delete password file
M-025	Fail to clear password	After clearance of password, the input of file has problem
M-026	Password file is deleted without authorization	Password file is deleted without authorization, please turn off machine
M-027	User ID file damaged	
M-028	Can not input blank	Input password again
M-029	Current password not match	Input current password again
M-030	New password not match	Input new password again
M-031	Enter touching panel correction mode	Are You Sure? Yes: enter No: X
M-032	Correction successful	Correction is successful, please restart machine
M-033	Correction failed	Please perform correction again
M-034	Clear warning record	Are You Sure? Yes: enter No: X
M-035	Periodical password is same to super password error	Input password again
M-036	Pattern data error	Current pattern data error, it will be replaced by default patterns
M-037	Pattern information file open failed	Restore to default pattern configuration
M-038	Memory full	Please delete the unused patterns
M-039	Cover the pattern	Are You Sure? Yes: enter No: X
M-040	P pattern open error	Pattern file has mistake, it will be deleted
M-041	C pattern open error	Pattern file has mistake, it will be deleted
M-042	Pattern is existed	Can not replace the pattern
M-043	Delete pattern data	Press Enter to delete; Press ESC to quit
M-044	Delete the selected pattern	Are You Sure? Yes: enter No: X
M-045	Pattern is used, can not delete	Please release the quotation at P or C pattern
M-046	Save at least one pattern	Can not delete last pattern
M-047	Load default patterns	No pattern in memory, please load default patterns
M-048	No pattern in memory	Press Enter to load default patterns
M-049	Pattern number not exist	Please input again
M-050	P pattern not exist	Please create P pattern
M-051	Save software version successful	Software version is saved to the root directory of U disk
M-052	Replace needle	Needle replacement set value is reached, please replace needle
M-053	Replace oil	Oil replacement set value is reached, please replace oil
M-054	Clean machine	Cleaning machine set value is reached, please clean machine
M-055	Clear needle replacement set value	Are You Sure? Yes: enter No: X
M-056	Clear oil replacement set value	Are You Sure? Yes: enter No: X
M-057	Clear cleaning time value	Are You Sure? Yes: enter No: X
M-058	Clear production control value	Are You Sure? Yes: enter No: X
M-059	Clear calculated running time	Are You Sure? Yes: enter No: X
M-060	Clear calculated sewing	Are You Sure? Yes: enter No: X

	number?	
M-061	Clear calculated power-on time?	Are You Sure? Yes: enter No: X
M-062	Clear calculated sewing stitch number?	Are You Sure? Yes: enter No: X
M-063	Clear calculated over-current times?	Are You Sure? Yes: enter No: X
M-064	Clear calculated stop times?	Are You Sure? Yes: enter No: X
M-065	Edit new pattern?	Are You Sure? Yes: enter No: X
M-066	Return to sewing mode?	Are You Sure? Yes: enter No: X
M-067	Restore all the settings	Are You Sure? Yes: enter No: X
M-068	Restore the selected items	Are You Sure? Yes: enter No: X
M-069	Not select an item	Please select one or several parameters
M-070	Sewing counter reaches set value	Please pres Enter to clear it
M-071	No.of pcs counter reaches set value	Please pres Enter to clear it
M-072	Successful	Current operation is successful
M-073	Failed	Current operation is failed
M-074	Copy failed	Check the room of memory
M-075	Copy failed	Check whether the U disk is pulled out
M-076	File I/O error	File I/O error
M-077	Verification failed at updating main software	
M-078	Can not delete pattern data	The selected sewing data is in use
M-079	Perform parameter transfer	Are You Sure? Yes: enter No: X
M-080	Can not open changed pattern	Please confirm pattern file
M-081	Changed pattern format error	Please confirm pattern file
M-082	Changed pattern data is too long	Please confirm pattern file
M-083	Update successful	Update successful, please restart machine
M-084	Fail to open file	Fail to open file
M-085	Parameter restoration successful	Parameter restoration successful, please restart machine
M-086	Not select update item	Please select at least one item for update
M-087	Selected item for update is not existed	If the item has no update file, the system will cancel the selection. If user wants to update the rest, please confirm again
M-088	Initialize U disk	Press Enter to perform operation; Press ESC to quit. The initialization will delete all the files in U disk
M-089	Initialize memory	Press Enter to perform operation; Press ESC to quit. The initialization will delete all the files in memory
M-090	Low memory	
M-091	Fail to select the function	
M-092	Shape point repeated error	

M-093	Can not return	
M-094	Can not find next stitch sewing data	
M-095	Can not find previous stitch sewing data	
M-096	Pattern data is too big	
M-097	Calculation error	
M-098	Pattern-designing error	
M-099	Cannot find the pattern	
M-100	Over moving range	
M-101	Over sewing range	Make sure pattern within sewing range
M-102	Stitch number over range	Reduce stitch number
M-103	Pattern file error	
M-104	Confirm to change point	
M-105	Confirm to insert auto trimming code	
M-106	Delete new pattern?	Press Enter to confirm; Press ESC to quit
M-107	Delete elements?	Press Enter to confirm; Press ESC to quit
M-108	Confirm to perform?	Press Enter to confirm; Press ESC to quit
M-109	Delete mechanical control order?	Press Enter to confirm; Press ESC to quit
M-110	Delete needle entry point	Press Enter to confirm; Press ESC to quit
M-111	Are you sure to move presser?	Press Enter to confirm; Press ESC to quit
M-112	Delete shape point	Press Enter to confirm; Press ESC to quit
M-113	Warning: Initialization will delete entire data in memory!	Press Enter to confirm; Press ESC to quit
M-114	Change model?	Press Enter to confirm; Press ESC to quit
M-115	Pattern is locked	Please unlock first
M-116	Can not modify basic pattern	
M-117	Turn off machine.	Current operation is finished, please restart machine
M-118	Can not modify counter	At modification, please turn off setting
M-119	Load basic pattern	Press ENTER to load basic pattern, don't turn off machine !
M-120	Restore to default setting?	Press Enter to confirm; Press ESC to quit
M-121	Clear entire custom parameters?	Are You Sure? Yes: enter No: X
M-122	Head board parameter error	Press ENTER to restore to default values
M-123	Pattern calculation error	
M-124	Delete all the P and C patterns	Press Enter to confirm; Press ESC to quit
M-125	Restore head board parameters?	Are You Sure? Yes: enter No: X
M-126	Over setting range	
M-127	Can not find customized pattern	This operation is only available for customized pattern. The basic pattern can not be outputted!
M-128	Outer presser is at upper position	Please lower the presser to perform the operation!

M-129	Can not perform right operation	
M-130	Can not find USB	Please insert U disk containing mp3 file
M-131	No video files in vid.avi	Please put vid.avi file into pdat directory in U disk and then enter the update interface to update video files
M-132	Whether to switch the 1903 to reinforce the foundation pattern	After switching parameters, all patterns will be deleted and the underlying patterns are reloaded.
M-133	Scaling failure	Needle spacing beyond upper and lower limits
M-134	Failure of curve generation	Please input again
M-135	Arc or circle generation failure	Please input again
M-136	Parameter setting exception	The generated pattern data exceeds the maximum needle length. Please check the parameter settings.
M-137	Length or radius parameter setting exception	<ol style="list-style-type: none"> 1. The length of the bottom seam exceeds the length of the sleeve. 2. Sleeve length is too long compared with bottom seam length. 3. The inner diameter exceeds the outer diameter of the pattern. 4. The height of half-month is lower than the distance of sleeve needle or the relative length of sleeve is too high. 5. Check parameter settings
M-138	Anomalies in needle spacing or number setting	Needle spacing is less than the minimum. Please check the needle spacing or needle number setting.
M-139	Sewing data exceeding maximum needle length	<ol style="list-style-type: none"> 1. Excessive distance between bottom stitches 2. Too large spacing of zigzag stitches 3. Please modify the parameter settings
M-140	Master version is too low	
M-141	Basic pattern error, need to upgrade basic pattern	
M-142	Upgrade Step End Check Error	
M-143	Failure of two-dimensional code display	
M-144	Whether to determine recovery step parameters	Are You Sure? Yes: enter No: X



富山IoT



微信公众号



抖音官方号

上海富山精密机械科技有限公司

HIKARI (SHANGHAI) PRECISE MACHINERY SCIENCE AND TECHNOLOGY CO., LTD

邮箱/E-mail: hikari@chinahikari.com

网址/Web: www.chinahikari.com

传真/Fax: (00)86-21-67311311

电话/Tel: (00)86-21-67311111 (转外贸部/ext .Foreign Trade Dept)

上海市金山区朱泾镇工业园区中达路800号

NO.800, ZHONGDA ROAD, ZHUJING INDUSTRIAL ZONE,

JINSHAN DISTRICT, SHANGHAI CHINA



QUANTITY ATTESTATION
ISO9001质量体系认证